

FRONT VIEW

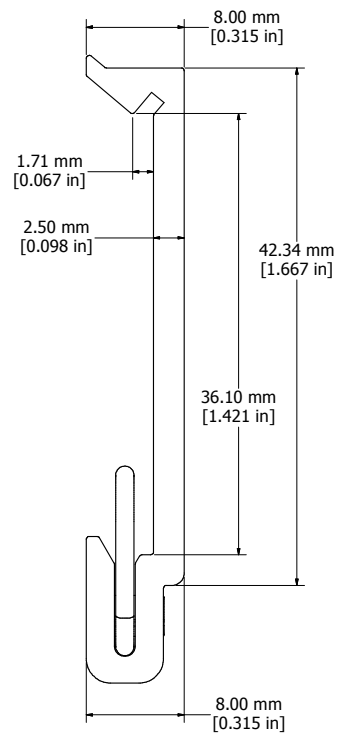

SIDE VIEW

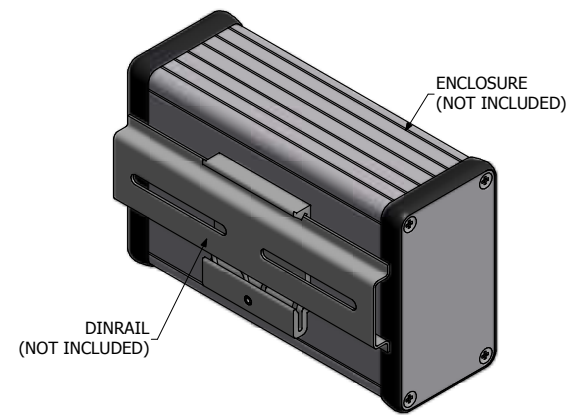

TYPICAL ASSEMBLY

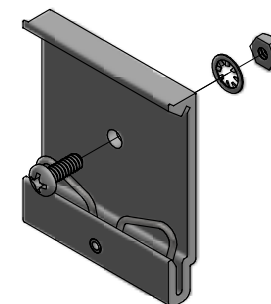

EXPLODED DINCLIP W/ HARDWARE

<b>1427DIN42M</b>
Material/Finish - Body - Clear Anodized Aluminum
- Spring - Galvanized Spring Steel Wire
<b>Hardware</b>
1 Screw - #6-32 x 3/8" Panhead
1 Nut - #6-32 Hex Nut
1 Washer - #6 Toothed Lockwasher



**HAMMOND  
MANUFACTURING™**

**1427DIN42M**

www.hammondmfg.com