

## Multipurpose Plastic Enclosures (1591 "S" Series) Economical Version

[Home](#)

[Products](#)

[Distributors](#)

[Technical](#)

[Contact Us](#)

[Other Options](#)

**Path:** [Home](#) > [Enclosure Index](#) > Multipurpose Plastic Enclosure - Economical Version



(click to enlarge)





























(click to enlarge)





(click to enlarge)

### ***Key Features:***

- Electronic instrument enclosures, ideally suited for mounting printed circuit boards.
- Integral card guides accept 1.5 mm (0.062") P.C. cards.
- Lap joint construction provides protection against access of dust and splashing water.
- Designed to meet IP54
- Molded from economical black or grey plastic
- Link here to our [flame retardant ABS plastic version](#).
- Lid is secured with self-tapping #4 x 0.5" philips screws (black screws included with black enclosures, nickel finish included with grey enclosures).
-  Link here to [photo tables](#) of each part number (shown in grey).

Part Number	Color	Reader File	 Drawing File Size	AutoCAD .dwg Files (zipped)	.zip File Size	Units	Length	Width	Enclosure Depth (Less Lid)
<b>1591MSBK</b> <b>1591MSGY</b>	Black Grey		151K		280K	Inches	3.3	2.2	0.8
						mm	85	56	21
<b>1591LSBK</b> <b>1591LSGY</b>	Black Grey		148K		212K	Inches	3.3	2.2	1.4
						mm	85	56	35
<b>1591ASBK</b> <b>1591ASGY</b>	Black Grey		161K		316K	Inches	3.9	2.0	0.8
						mm	100	50	21
<b>1591SSBK</b> <b>1591SSGY</b>	Black Grey		145K		220K	Inches	4.3	3.2	1.6
						mm	110	82	40
<b>1591BSBK</b> <b>1591BSGY</b>	Black Grey		148K		332K	Inches	4.4	2.4	1.1
						mm	112	62	27
<b>1591CSBK</b> <b>1591CSGY</b>	Black Grey		222K		251K	Inches	4.7	2.6	1.4
						mm	120	65	36
<b>1591TSBK</b> <b>1591TSGY</b>	Black Grey		142K		203K	Inches	4.7	3.2	2.2
						mm	120	80	55
<b>1591USBK</b> <b>1591USGY</b>	Black Grey		111K		273K	Inches	4.7	4.7	2.2
						mm	120	120	55
<b>1591VSBK</b> <b>1591VSGY</b>	Black Grey		131K		191K	Inches	4.7	4.7	3.5
						mm	120	120	90
<b>1591GSBK</b> <b>1591GSGY</b>	Black Grey		154K		344K	Inches	4.8	3.7	1.2
						mm	121	94	30
<b>1591DSBK</b> <b>1591DSGY</b>	Black Grey		154K		245K	Inches	5.9	3.2	1.8
						mm	150	80	46
<b>1591HSBK</b> <b>1591HSGY</b>	Black Grey		171K		566K	Inches	6.5	2.8	1.0
						mm	165	71	25

<b>1591ESBK</b> <b>1591ESGY</b>	Black		151K		259K	Inches	7.5	4.3	2.2
	Grey					mm	191	110	57

 Link here to [photo tables](#) of each part number (shown in grey).

**NOTES:**

- Add 0.16" (4 mm) to enclosure depth for lid

**Accessories**

**Flange Kits:**

[Link Here For Details](#)

**Top View**



click to enlarge

**Bottom View**



click to enlarge

**P.C. Board Card Adaptors:**

Part Number **1591Z6** - Package of 6

Part Number **1591Z50** - Package of 50

Part Number **1591Z100** - Package of 100

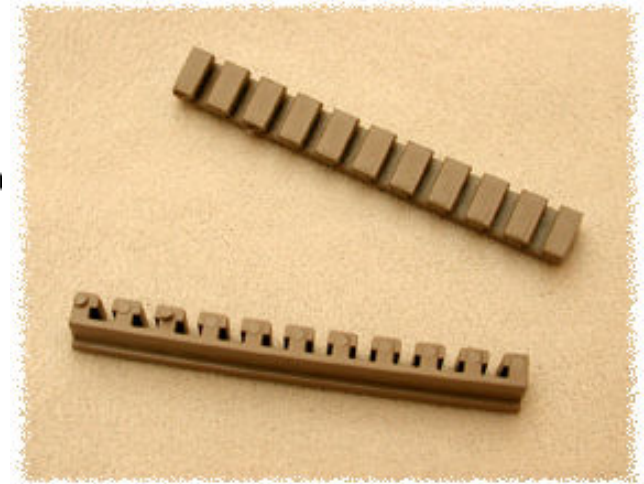
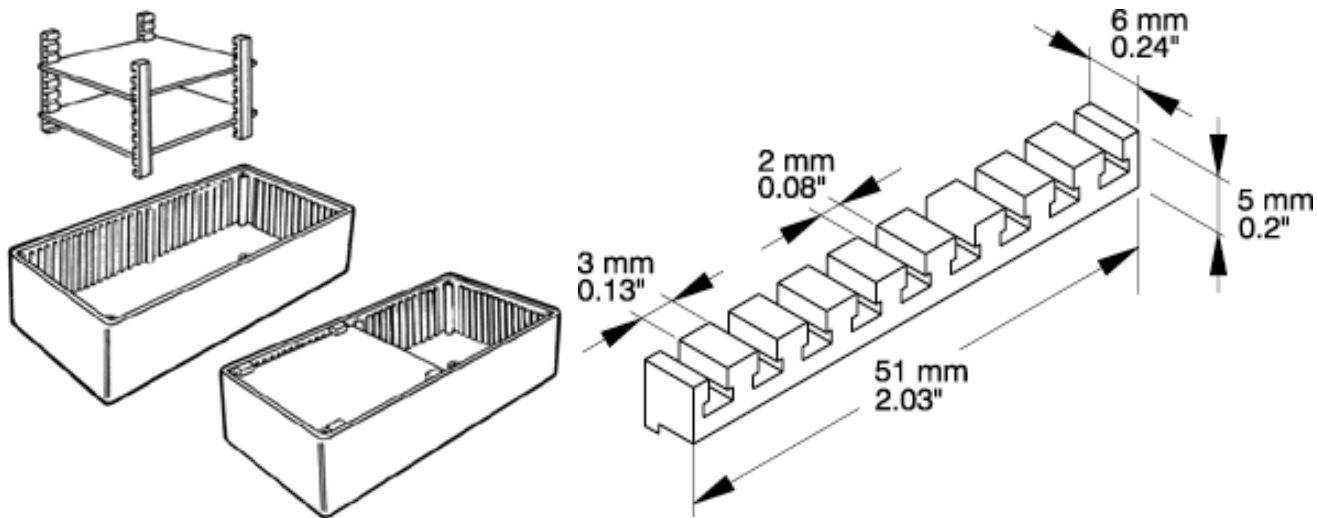

### Belt or Pocket Clip:



- Molded from tough nylon.
- Includes 2 nylon screws (insulated to avoid internal interference).
- Mounting template included.

Black - Part Number **1599CLIP**

Grey (shown) - Part Number **1599CLIPGY**

### Clear Lids:

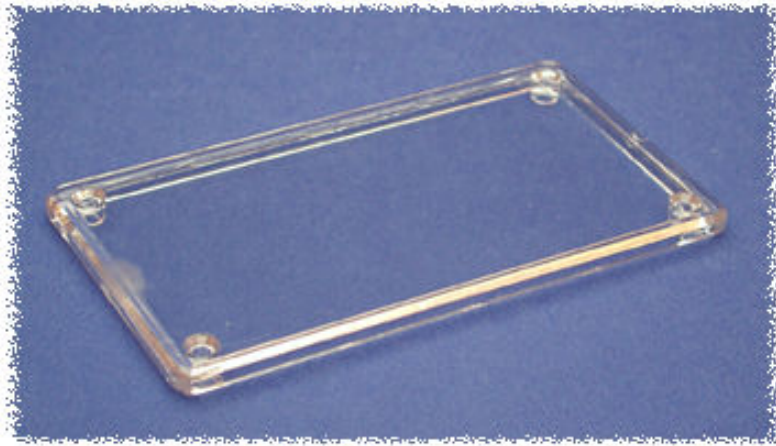

- Clear Polycarbonate - flame retardant material
- Enclosure is NOT included
- For clear lid and enclosure - see our [1591 "T" series](#)

Part Number	Use With Enclosure Series
<b>1591LC</b>	1591L & 1591M
<b>1591AC</b>	1591A
<b>1591BC</b>	1591B
<b>1591CC</b>	1591C
<b>1591DC</b>	1591D
<b>1591EC</b>	1591E
<b>1591GC</b>	1591G
<b>1591HC</b>	1591H
<b>1591SC</b>	1591S
<b>1591TC</b>	1591T
<b>1591UC</b>	1591U
<b>1591VC</b>	1591V

---

[DOWNLOAD](#)

catalog pages on this series (145K) [9C-1591S.pdf](#)

---

Exactly what you are looking for???

[Link to our stocking distributors - most have "on-line" pricing, stock check and ordering!!!](#)

**Our Distributors**

**Order from your favorite distributor**

---

**[Home](#) | [Products](#) | [Distributors](#) | [Technical](#) | [Contact Us](#) | [Other Options](#)**

---

Copyright; © 1997-2007 Hammond Mfg Co Inc

URL: <http://www.hammondmfg.com>

# 1591E Enclosure

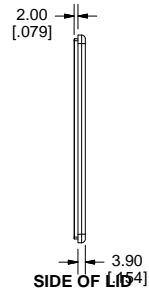
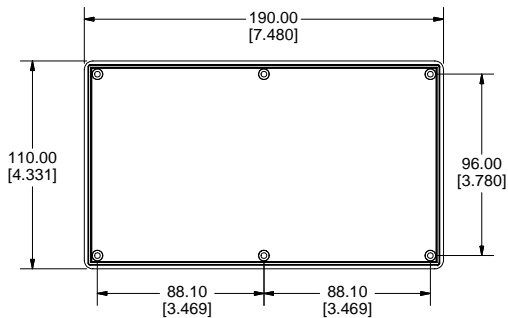
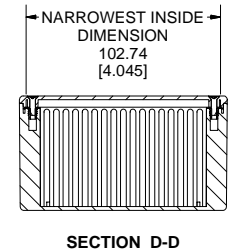
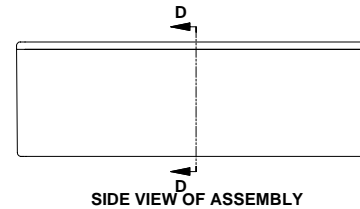
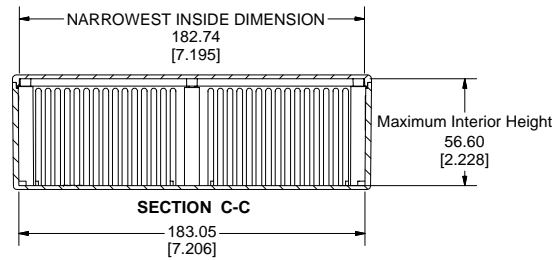
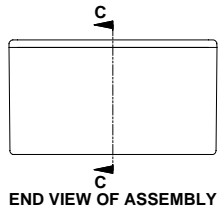
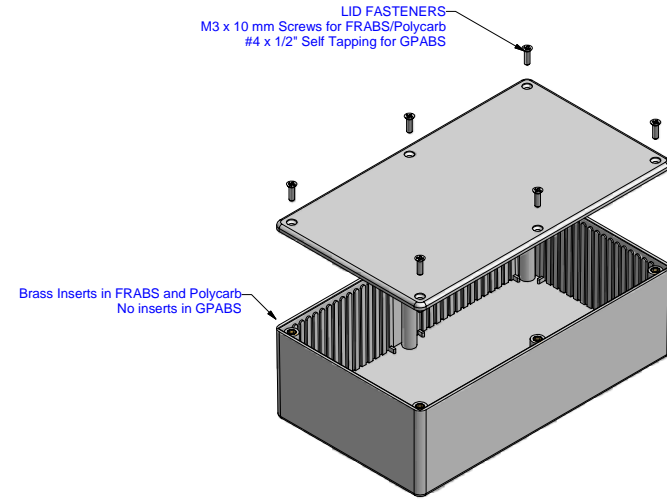
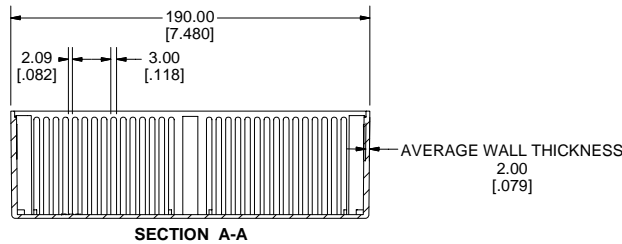
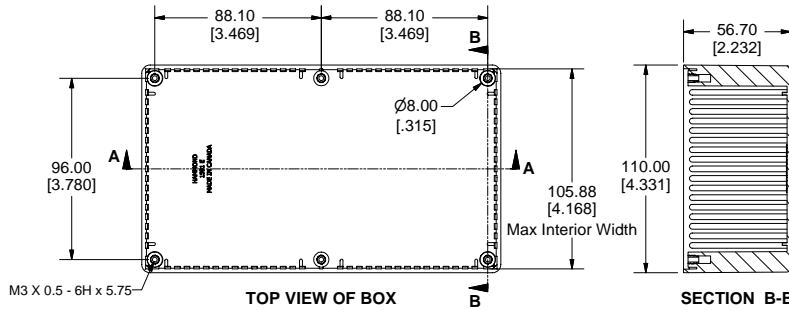
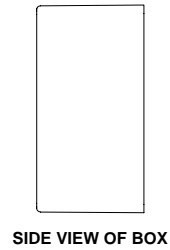

**Note:**  
Enclosures can be Factory Modified ( Milling, Drilling, Printing etc. )  
Solid models of this enclosure available in STEP or IGES Format.  
Contact Factory [mjm@hammondmfg.com](mailto:mjm@hammondmfg.com)



PART NUMBERS		
1591E Enclosures		
Material	Colour	Part Number
FR ABS UL94 - V0	Black	1591EBK
	Grey	1591EGY
GP ABS	Black Shielded ( Conductive Paint )	1591REBK
	Black	1591ESBK
Translucent Polycarbonate	Grey	1591ESGY
	Ice Blue	1591ETBU
Polycarbonate	IR Red	1591ETRD
	Crystal Clear	1591ETCL
Accessories		
	Description	Part Number
Universal Application	PC Board Card Adapters	See Accessories Section
	Flange Kits	See Accessories Section
	Clear Lids - clear, flame retardant polycarbonate - Lid ONLY	1591EC
FR ABS & Polycarbonate	Replacement Screws, Flat head Phillips, Nickel Plated Pkg of 100	1591MS100
GP ABS	Self Tapping Pkg of 100	1591MS100BK (Black)
		1591TS100
	1591TS100BK ( Black)	
Required Torque on Fasteners (no lubrication)		
	M3 - 0.5 x 10mm Screws	30-40 cN*m
	#4 x 0.5 Screws	30-40 cN*m