

# SMT LOW PROFILE LITHIUM & ALKALINE CELL HOLDERS

"1/3N" · "AAA" · "1/2AA" · "AA" · "2/3A"

AVAILABLE ON TAPE AND REEL

## FEATURES

- Low profile surface mount holders for Cylindrical Lithium and Alkaline batteries
- UL 94V-0 Heat resistant Nylon Housings well suited for reflow soldering
- Designed for vacuum pick and place assembly
- Gold-plated Phosphor Bronze contacts assure low contact resistance and are readily solderable

- Ideal for both lead free solder and traditional solder process
- Battery installation and removal does not require tools
- Securely holds battery in place
- Polarity clearly marked for orientation
- Operating temp range: -60°F to +290°F (-50°C to +145°C)

## APPLICATIONS

- Computer memory, power backup systems
- Telecommunications
- Residential, industrial and commercial security systems
- PLC and industrial controls

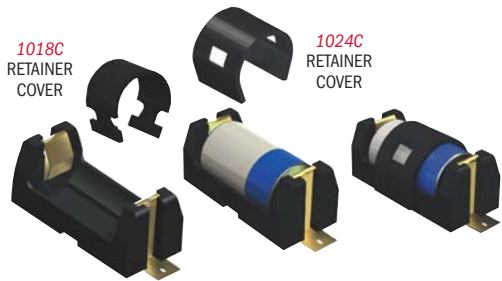

## SMT ULTRA LOW PROFILE

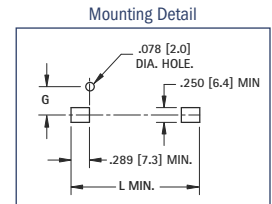
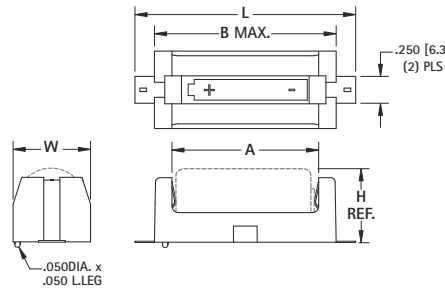

## SPECIFICATIONS

Base: High Temp Nylon 46, UL 94V-0

Contacts: .012 (.30) Phosphor Bronze, Gold Plate (Flash)

CAT. NO.	ON TAPE BULK	ON TAPE & REEL COVER	L	W	H (REF)	A	B (MAX)	G	CELL SIZE	TAPE & REEL SPECS PACKED ON 13" REEL	BATTERY CROSS REFERENCE
1016	1016TR	1024C	1.723 (43.8)	.612 (15.5)	.603 (15.3)	1.030 (26.2)	1.360 (34.5)	.265 (6.7)	"1/2 AA"	56mm wide, 24mm pitch, 125 pcs/reel	Energizer 544, Duracell PX28L, Kodak K28A & KS28, Panasonic CR14250, Saft LCP3, Maxell 4LR44, Sanyo CR14250SE
1024	1024TR	1024C	2.711 (68.9)	.612 (15.5)	.603 (15.3)	2.040 (51.8)	2.359 (59.9)	.265 (6.7)	"AA"	88mm wide, 28mm pitch, 100 pcs/reel	Energizer, Duracell, Panasonic, Sanyo, Varta, Rayovac, Tadiran
1018	1018TR	1018C	2.053 (52.2)	.720 (18.3)	.682 (17.3)	1.365 (34.7)	1.690 (42.9)	.319 (8.1)	"2/3 A"	72mm wide, 32mm pitch, 100 pcs/reel	Duracell DL2/3A, Kodak K123L, Panasonic CR123A, Saft 450SC & VR0450, Sanyo CR17335SE

## SMT ULTRA LOW PROFILE



## SINGLE

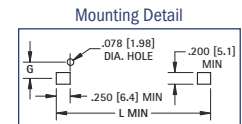
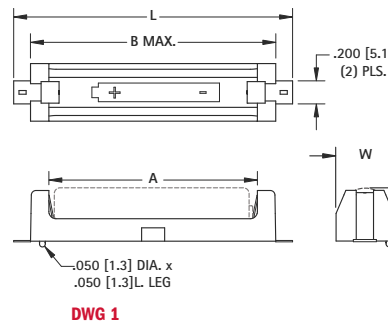

## SPECIFICATIONS

Base: High Temp Nylon 46, UL 94V-0

Contacts: .012 (.30) Phosphor Bronze, Gold Plate (Flash)

Operating Temp: -60°F to +290°F (-50°C to +145°C)

DWG 1

## DUAL

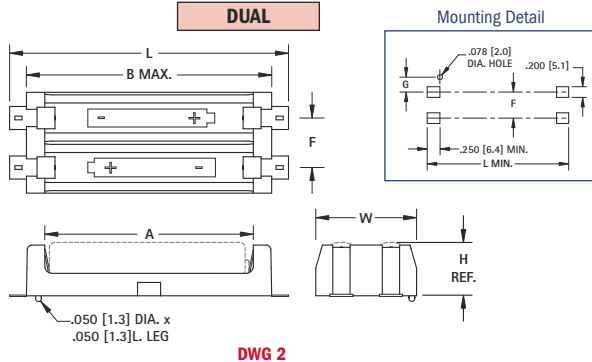

DWG 2

## "1/3N"

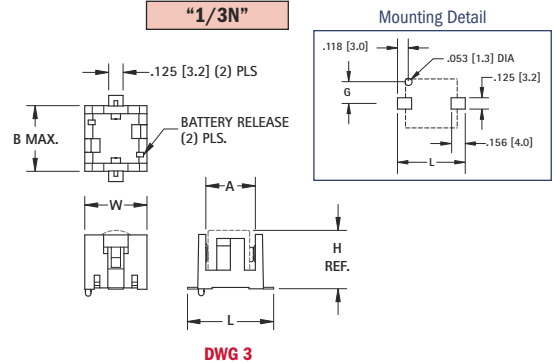

DWG 3

CAT. NO.	ON TAPE BULK	ON TAPE & REEL COVER	DWG NO.	L	W	H (REF)	A	B (MAX)	F	G	CELL SIZE	TAPE AND REEL SPECS PACKED ON 13" REEL	BATTERY CROSS REFERENCE
1020	1020TR	1020C	1	2.421 (61.5)	.500 (12.7)	.445 (11.3)	1.810 (46.0)	2.140 (54.4)	-	.209 (5.3)	"AAA"	88mm Wide, 24mm pitch, 200 pcs/reel	Energizer, Duracell, Panasonic, Sanyo, Varta, Rayovac, Tadiran
1022	1022TR	1022C	2	2.421 (61.5)	.875 (22.2)	.445 (11.3)	1.810 (46.0)	2.140 (54.4)	.430 (10.9)	.182 (4.6)	"AAA"	88mm Wide, 32mm pitch, 125 pcs/reel	Energizer, Duracell, Panasonic, Sanyo, Varta, Rayovac, Tadiran
1024	1024TR	1024C	1	2.711 (68.9)	.612 (15.5)	.603 (15.3)	2.040 (51.8)	2.359 (59.9)	-	.265 (6.7)	"AA"	88mm wide, 28mm pitch, 100 pcs/reel	Energizer, Duracell, Panasonic, Sanyo, Varta, Rayovac, Tadiran
1012	1012TR	1012C	2	2.711 (68.9)	1.180 (30.0)	.603 (15.3)	2.040 (51.8)	2.359 (59.9)	.568 (14.4)	.265 (6.7)	"AA"	88mm Wide, 48mm pitch, 100 pcs/reel	Energizer, Duracell, Panasonic, Sanyo, Varta, Rayovac, Tadiran
498	498TR	-	3	.748 (19.0)	.540 (13.7)	.506 (12.9)	.430 (10.9)	.570 (14.5)	-	.240 (6.1)	"1/3 N"	44mm Wide, 24mm pitch, 125 pcs/reel	Duracell DL1/3N, Sanyo K58L, Energizer CR1/3N