



Designers' Choice

# BATTERY CLIPS & CONTACTS

## SNAP-IN PC BATTERY CLIPS FOR "A" • "AA" • "AAA" • "AAAA" • "N" SIZES

- Available for "A" • "AA" • "AAA" • "AAAA" • "N" size batteries
- Mounts securely to the PC board with advanced "Snap-In" design for thru hole mounting
- "Snap-In" clip holds firmly for wave soldering
- Reliable spring tension assures low contact resistance
- Low profile, economical design
- Retains battery securely to withstand shock and vibration

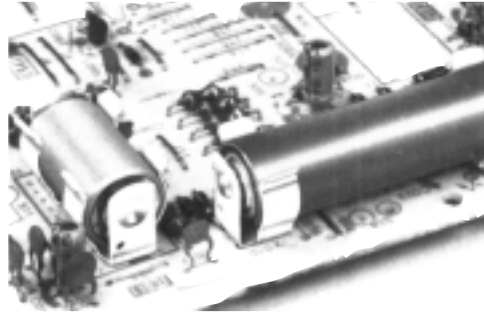

Mounting Detail

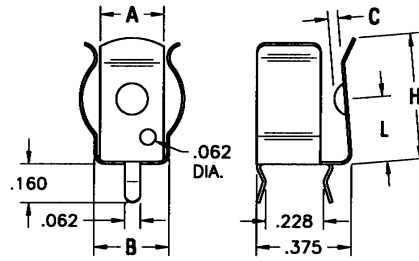
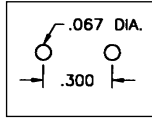

MATERIAL: Spring Steel, Nickel Plate



No Ears

CAT. NO.	BATTERY SIZE	BATTERY DIA.	A	B	C	H	L	MAT'L THICK
52	"A" • "AA"	No Ears	.250	—	.040	.500	.260	.010
92	"A" • "AA"	.531-.665	.312	.375	.060	.593	.359	.012
2915	"A" • "AA"	.531-.665	.312	.375	.060	.593	.359	.015
82	"AAA" • "N"	.375-.460	.250	.300	.040	.500	.260	.010
51	"AAAA"	.300-.350	See drawing below					.010

New

## SURFACE MOUNT BATTERY CLIP

For "AAA" • "N"

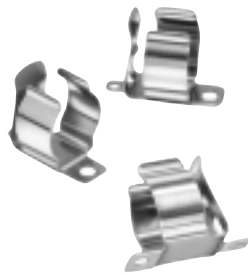

- Low profile for densely packed PCBs
- "Flow-Hole" SMT solder tail design for increased joint strength
- Retains cell securely, withstands shock and vibration
- All conductive polystyrene carrier tape meets ANSI/EIA -481 standard

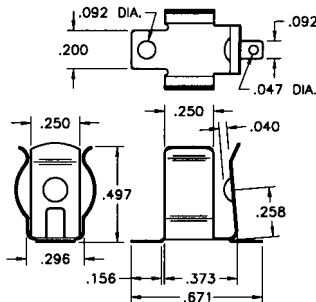

Pad Layout

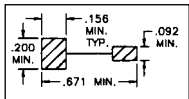

MATERIAL: .010 Spring Steel, Tin Plate  
Tape & Reel Specs: 32mm wide; 16mm pitch; 13 inch reel, (300 pieces per reel)

CAT. NO. 55 (Bulk)

CAT. NO. 55TR (Tape and Reel)

"AAAA"

MATERIAL: .010 Spring Steel, Nickel Plate

CAT. NO. 51

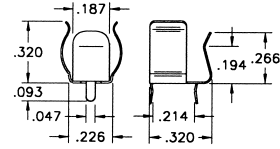

Mounting Detail



## ECONOMY CLIPS FOR "AA" • "C" • "D" SIZES

Designed for mounting in self-contained, non-metallic battery compartments. Reliable spring tension assures low contact resistance. Recessed contact holds battery in place. All clips have anti-rotation tab.

MATERIAL: .016 Spring Steel, Nickel Plate

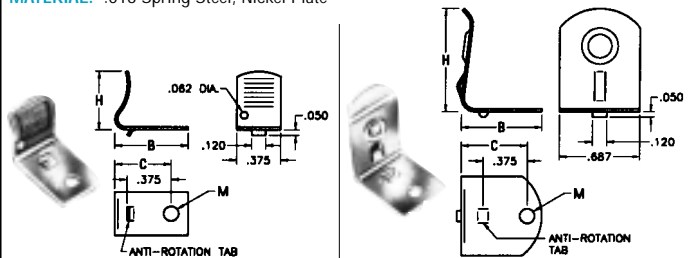
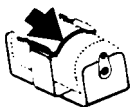

FIG. 1

FIG. 2

CAT. NO.	FIG. NO.	B	C	H	M MTHG. HOLE	CELL SIZE
206	1	.625	.480	.500	.128	AA
207	2	.687	.547	.875	.128	C
208	2	.750	.562	1.260	.128	D

## BATTERY RETAINER CLIPS



- Prevents battery from loosening in battery holder
- Retainer clip slips on the ears of the battery holder clip
- Manufactured from Spring Steel, Nickel plate

CAT. NO. 61

Retainer for "AA" or cells with diameters of .532" to .562". Used with Keystone Battery Clips Cat. No. 91, 92, 92-015, 95, 99 and 100.

CAT. NO. 62

Retainer for "C" cells or similar size batteries to 1.032" diameter. Used with Keystone Battery Clips Cat. No. 86, 87, 93 and 222.

CAT. NO. 63

Retainer for "D" cells or similar size batteries to 1.343" diameter. Used with Keystone Battery Clips Cat. No. 88, 89 and 94.

## BATTERY SPRING CONTACTS

For "A" • "AA" • "C" • "D" Sizes

Easy to assemble with eyelets or rivets.

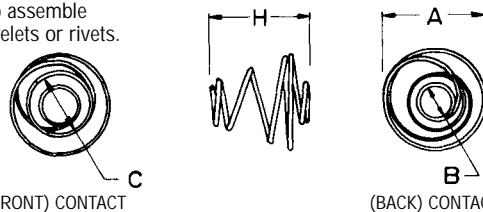

(FRONT) CONTACT

(BACK) CONTACT

CAT. NO.	H	A	B	C	MATERIAL
211 ("A" • "AA")	.290	.335	.100	.140	.025 Dia. Spring Steel, Nickel Plate
211-D ("C" • "D")	.850	.650	.162	.300	.040 Dia. Spring Steel, Nickel Plate