

■ Features :

- 2/3/8 stage charging (Note 4)
- Universal AC input / Full range
- Built-in active PFC function PF>0.95
- Protection: Reverse polarity / Short circuit / Over voltage / Over temperature
- Charger for lead-acid batteries
- 3 color LED loading indicator
- Built-in remote ON-OFF control
- Built-in temperature compensation function
- Built-in fan speed control (depends on charging current)
- 3 years warranty

SPECIFICATION

MODEL	PB-600-12	PB-600-24	PB-600-48	
OUTPUT	BOOST CHARGE VOLTAGE	14.4V	28.8V	57.6V
	FLOAT CHARGE VOLTAGE	13.8V	27.6V	55.2V
	RECOMMENDED BATTERY CAPACITY(AMP HOURS)(Note 3)	135 ~ 400AH	70 ~ 210AH	35 ~ 105AH
	BATTERY TYPE	Open & Sealed Lead Acid		
	OUTPUT CURRENT	40A	21A	10.5A
INPUT	VOLTAGE RANGE	90 ~ 264VAC	127 ~ 370VDC	
	FREQUENCY RANGE	47 ~ 63Hz		
	EFFICIENCY (Typ.)	86%	87%	89%
	POWER FACTOR (Typ.)	0.95/230VAC	0.98/115VAC at full load	
	AC CURRENT (Typ.)	6.8A/115VAC	3.4A/230VAC	
	INRUSH CURRENT (Typ.)	25A/115VAC	50A/230VAC	
LEAKAGE CURRENT	<3.5mA / 240VAC			
PROTECTION	OVER VOLTAGE	16 ~ 18V	32 ~ 35V	64.5 ~ 69.5V
	OVER TEMPERATURE	Protection type : Shut down o/p voltage, re-power on to recover		
FUNCTION	REMOTE CONTROL	Open: Normal work Short: Stop Charging		
	LEAKAGE CURRENT FROM BATTERY (Typ.)	1mA		
	FAST CHARGE	2 / 3 / 8 stage selectable		
	CHARGING OK	Relay contact (RY15)		
	OUTPUT OK	Relay contact (RY13)		
	TEMPERATURE SENSE	By NTC		
ENVIRONMENT	WORKING TEMP.	-20 ~ +60°C (refer to output load derating curve)		
	WORKING HUMIDITY	20 ~ 90% RH non-condensing		
	STORAGE TEMP., HUMIDITY	-40 ~ +85°C, 10 ~ 95% RH		
	TEMP. COEFFICIENT	±0.05%/°C (0 ~ 50°C)		
SAFETY & EMC (Note 2)	VIBRATION	10 ~ 500Hz, 2G 10min./1cycle, 60min. each along X, Y, Z axes		
	SAFETY STANDARDS	UL1012, TUV EN60335-1, EN60335-2-29 (except for 48V) approved		
	WITHSTAND VOLTAGE	I/P-O/P:3KVAC I/P-FG:1.8KVAC O/P-FG:0.5KVAC		
	ISOLATION RESISTANCE	I/P-O/P, I/P-FG, O/P-FG:100M Ohms / 500VDC / 25°C / 70% RH		
	EMI CONDUCTION & RADIATION	Compliance to EN55022 (CISPR22)		
	HARMONIC CURRENT	Compliance to EN61000-3-2,-3		
OTHERS	EMS IMMUNITY	Compliance to EN61000-4-2,3,4,5,6,8,11; ENV50204, EN55024; light industry level, criteria A		
	MTBF	135.6Khrs min. MIL-HDBK-217F (25°C)		
	DIMENSION	230*158*67mm(L*W*H)		
NOTE	PACKING	2.2Kg; 6pcs/14.2Kg/1.76CUFT		
	1. All parameters NOT specially mentioned are measured at 230VAC input, rated load and 25°C of ambient temperature. 2. The power supply is considered a component which will be installed into a final equipment. The final equipment must be re-confirmed that it still meets EMC directives. 3. This is Mean Well's suggested range. Please consult your battery manufacturer for their suggestions about maximum charging current limitation. 4. Please choose the "3 stage" selection when the charger is used to charge the batteries and power the loads in the same time.			

Mechanical Specification

Case No.805C Unit:mm

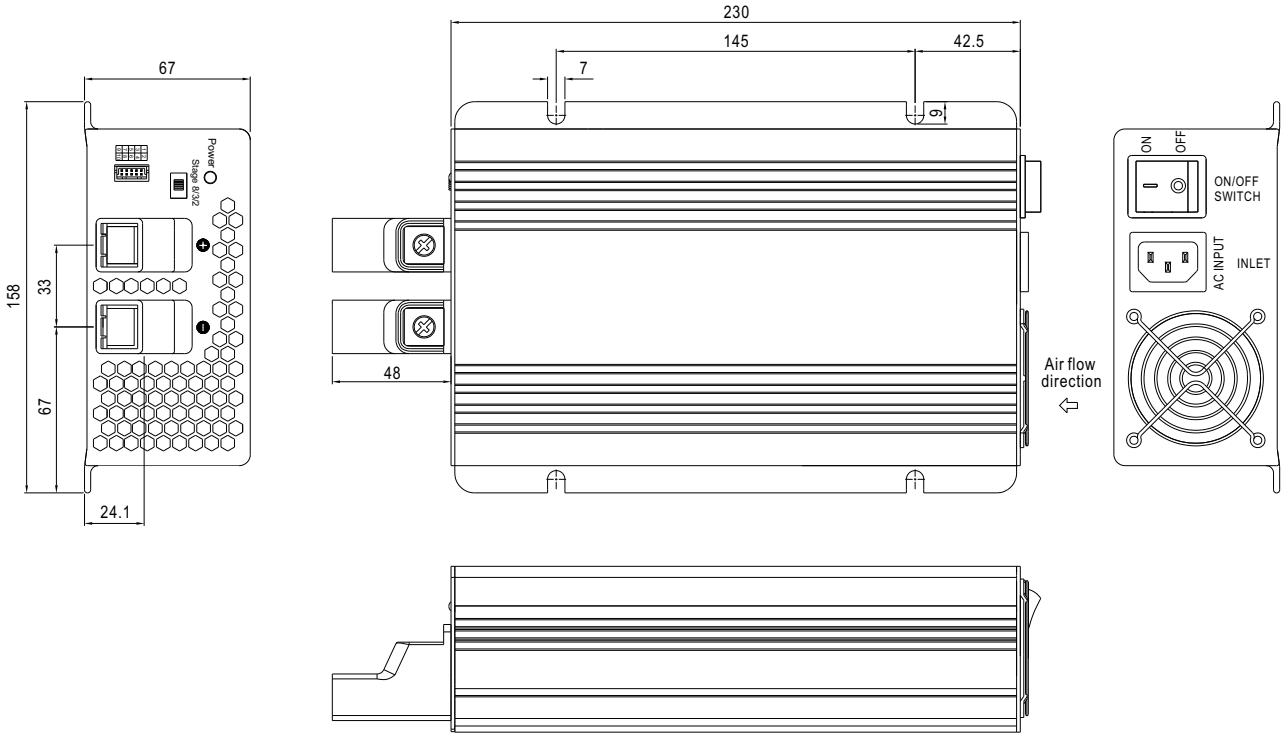

Control Pin No. Assignment(CN100) : HRS DF11-10DP-2DS or equivalent

Pin No.	Assignment	Pin No.	Assignment	Mating Housing	Terminal
1,2	RY13	8	NTC(5KΩ)	HRS DF11-10DS or equivalent	HRS DF11-10DS or equivalent
3,4	NC	9	RC-		
5,6	RY15	10	RC+		
7	GND				

RY13 : Battery bank OK NTC / GND : Temperature sense
 RY15 : Charging OK RC+ / RC- : Remote ON/OFF

Charging Curve

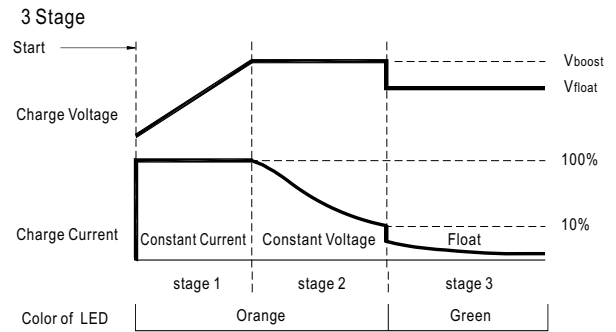
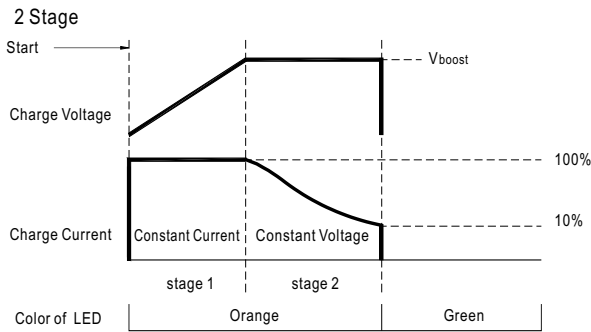

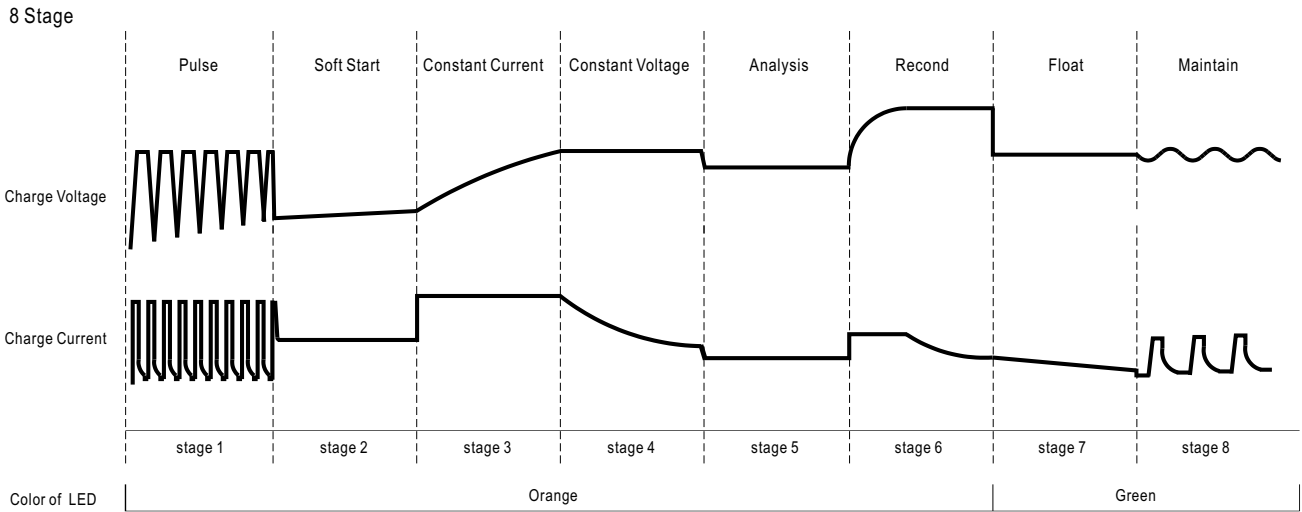

■ **Block Diagram**

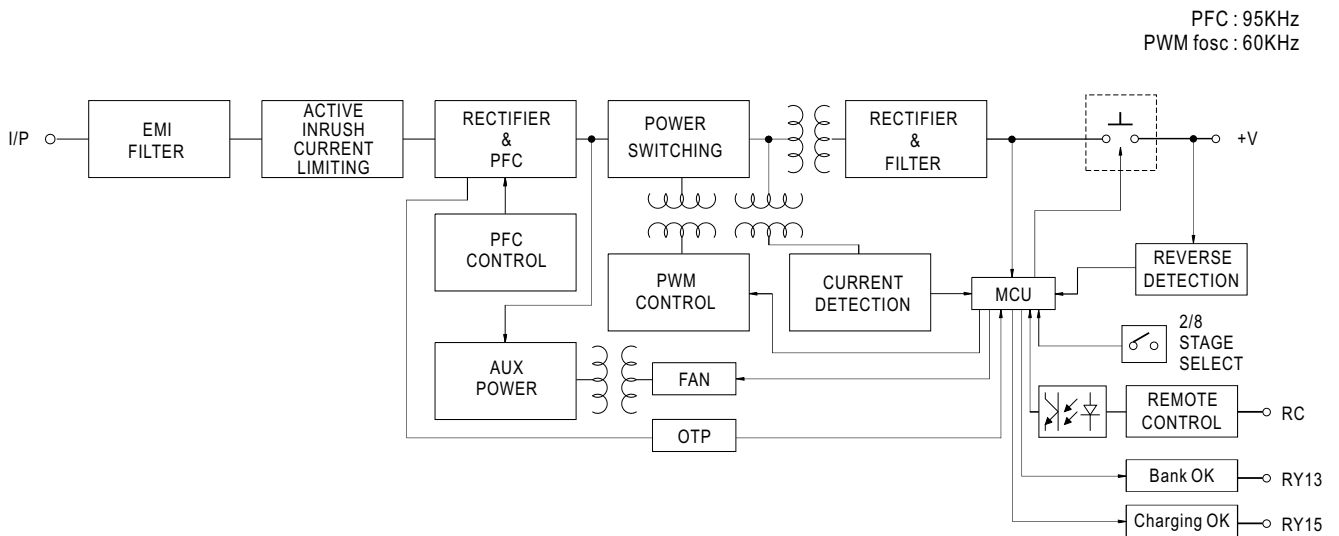

■ **Derating Curve**

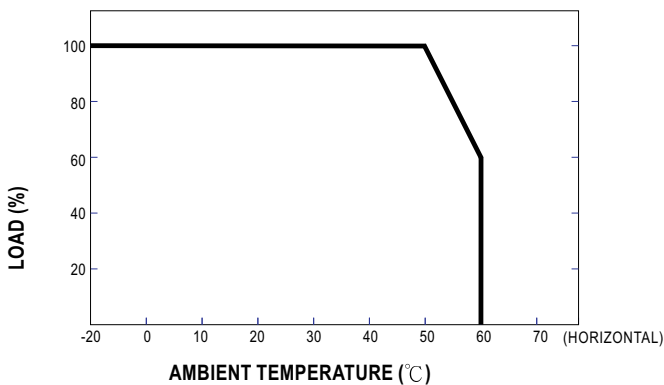

■ **Static Characteristics**

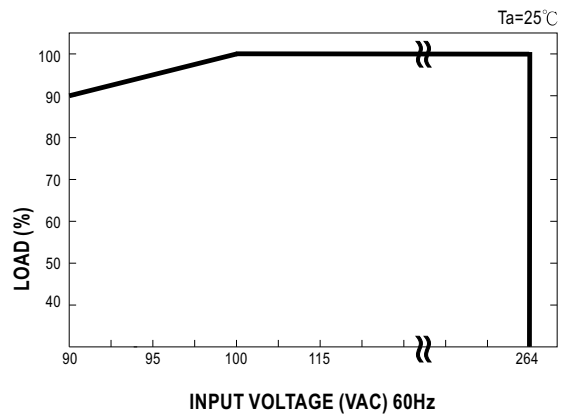

■ Function Description of CN100

Pin No.	Function	Description
1,2	RY13	Relay contact rating(max.): 30V/1A resistive.; "Short" when the battery is full, "Open" when the battery is still charging
5,6	RY15	Relay contact rating(max.): 30V/1A resistive.; "Short" when the unit is working properly, "Open" when the unit stop charging
7,8	GND / RTH	Temperature sensor comes along with the charger can be connected to the unit to allow temperature compensation of the charging voltage
9,10	RC- / RC+	Turn the output on and off by electrical or dry contact between pin 10 (RC+) and pin 9(RC-) Open : Normal work , Short : Stop charging

■ The Function of LEDs

Battery	Color of LED
Fail	Red
Charging	Orange
Battery Full	Green

■ Function Manual

1.Remote Control

The charger can be turned ON/OFF by using the "Remote Control" function.

Between RC+(pin10) and RC-(pin9)	Charging
SW Open	ON
SW Short	OFF

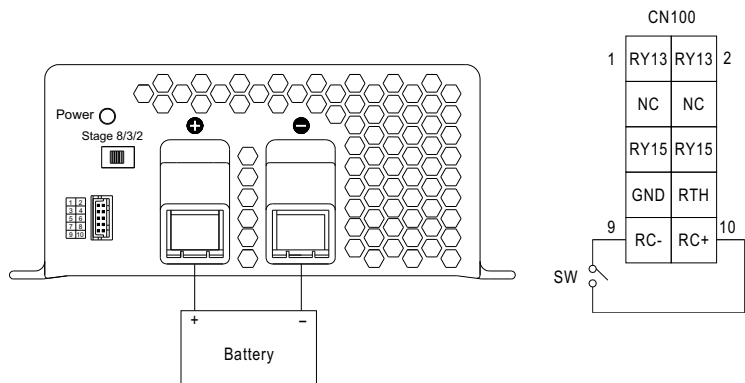

2. 2,3, or 8 stage charging select

(1)The charger features user selectable 2,3, or 8 stage charging.

The charging profile is selected by moving the slide switch on the back panel.

Switch	Charging mode
Right	2 stage charging
Middle	3 stage charging
Left	8 stage charging

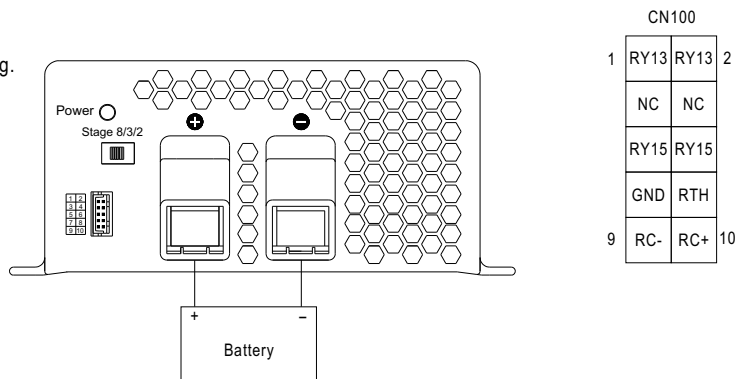

(2)Please choose the "3 stage" selection when the charger is used to charge the batteries and power the loads in the same time.

3.Charger OK Relay(RY15)

Charger	Between pin5 and pin6(RY15)
Normal work	ON (Short)
Failure or the protection function is activating	OFF (Open)

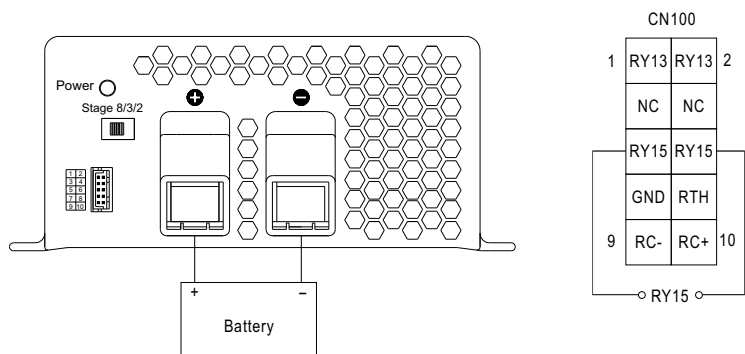

4. Output OK (RY13)

1. Bank OK (RY13)

Bank	Between pin 1 and pin 2 (RY13)	Color of LED
Battery Full	ON (Short)	Green
Charging	OFF (Open)	Orange

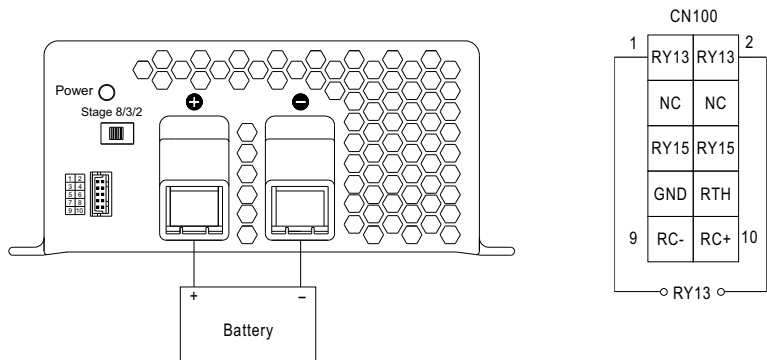

5. Temperature compensation

Temperature sensor comes along with the charger can be connected to the unit to allow temperature compensation of the charging voltage. If the sensor is not used, the charger still works normally.

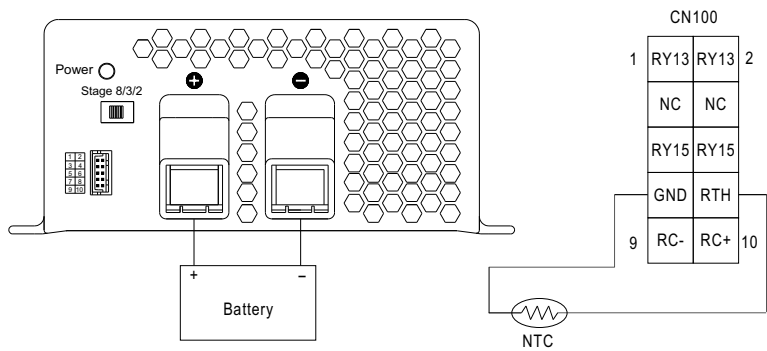

The temperature sensor can either be attached to the battery or placed in its surrounding environment.