

The Standard for Photoelectric Sensors with a Secure Track Record of One Million Sold Yearly.



- Long sensing distance of 30 m for Through-beam Models, 4 m for Retro-reflective Models, and 1 m for Diffuse-reflective Models.
- Mechanical axis and optical axis offset of less than $\pm 2.5^\circ$ simplifies optical axis adjustment.
- High stability with unique algorithm that prevents interference of external light.



For the most recent information on models that have been certified for safety standards, refer to your OMRON website.

Be sure to read *Safety Precautions* on page 13.

Features

Industry's Top-level Sensing Distance with Built-in Amplifier

A separately sold filter is available to prevent mutual interference for Through-beam Models with red lights sources and a sensing distance of 10 m. Reflective Models include functionality to prevent mutual interference (up to 2 sensors).

Long-distance, Through-beam Sensors with a detection distance of 30 m (response time: 2 ms) are also available.

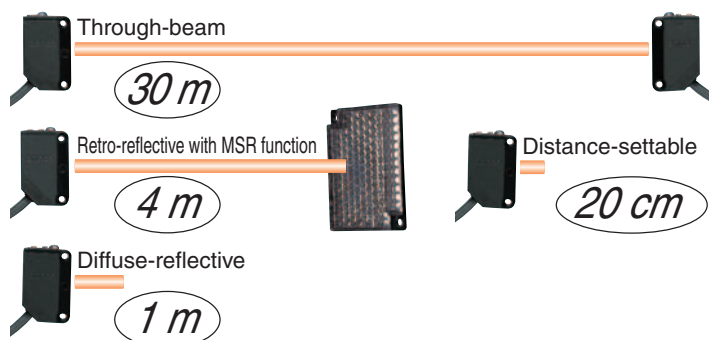

Low-temperature Operation for Applications in Cold-storage Warehouses

A wider ambient operating range from -40 to 55°C (main models with connectors). We also provide Sensor I/O Connectors with PUR Cables for high resistance to cold environments.

Improved Matching of Optical Axis and Mechanical Axis for Through-beam Models and Retro-reflective Models

The offset between the optical axis and the mechanical axis is kept within $\pm 2.5^\circ$, so the optical axis can be accurately set simply by mounting the Sensor according to the mechanical axis.

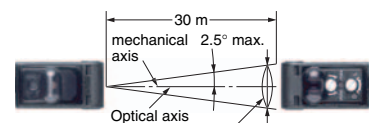

The receiver will always be in the range of light diffusion.

Sensor Protection against Incorrect Wiring

The Sensor includes output reverse polarity protection. (A diode to protect against reverse polarity is added to the output line.)

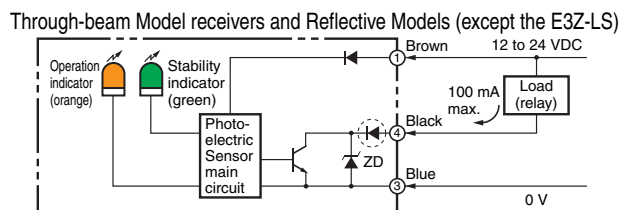

Protection for NPN output models

Complete Compliance with the EU's RoHS Directive



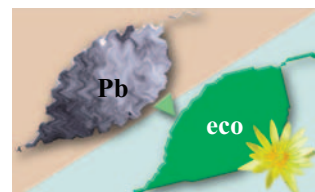







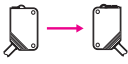



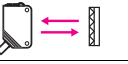

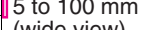

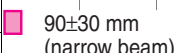
Lead, mercury, cadmium hexachrome, polybrominated biphenyl (PBB), and polybrominated diphenyl ether (PBDE) have all been eliminated. Also, burnable polyethylene packaging has been used.

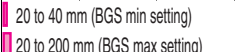
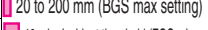

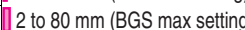
Ordering Information

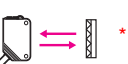
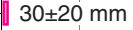
Sensors [Refer to Dimensions on page 14.]

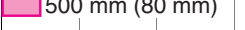
 Red light  Infrared light

| Sensing method | Appearance | Connection method | Sensing distance | Model | |
|--|---|-----------------------|---|--|--|
| | | | | NPN output | PNP output |
| Through-beam (Emitter + Receiver) *3 |  | Pre-wired (2 m) |  15 m | E3Z-T61 2M *4 *5 Emitter E3Z-T61-L 2M Receiver E3Z-T61-D 2M | E3Z-T81 2M *4 *5 Emitter E3Z-T81-L 2M Receiver E3Z-T81-D 2M |
| | | Standard M8 connector | | E3Z-T66 Emitter E3Z-T66-L Receiver E3Z-T66-D | E3Z-T86 Emitter E3Z-T86-L Receiver E3Z-T86-D |
| | | Pre-wired (2 m) |  10 m | E3Z-T61A 2M *4 Emitter E3Z-T61-A-L 2M Receiver E3Z-T61-A-D 2M | E3Z-T81A 2M *4 Emitter E3Z-T81-A-L 2M Receiver E3Z-T81-A-D 2M |
| | | Standard M8 connector | | E3Z-T66A Emitter E3Z-T66-A-L Receiver E3Z-T66-A-D | E3Z-T86A Emitter E3Z-T86-A-L Receiver E3Z-T86-A-D |
| | | Pre-wired (2 m) |  30m | E3Z-T62 2M *4 Emitter E3Z-T62-L 2M Receiver E3Z-T62-D 2M | E3Z-T82 2M Emitter E3Z-T82-L 2M Receiver E3Z-T82-D 2M |
| | | Standard M8 connector | | E3Z-T67 Emitter E3Z-T67-L Receiver E3Z-T67-D | E3Z-T87 Emitter E3Z-T87-L Receiver E3Z-T87-D |
| Retro-reflective with MSR function |  | Pre-wired (2 m) |  4 m *2 (100 mm) | E3Z-R61 2M *4 *5 | E3Z-R81 2M *4 *5 |
| | | Standard M8 connector | | E3Z-R66 | E3Z-R86 |
| Diffuse-reflective |  | Pre-wired (2 m) |  5 to 100 mm (wide view) | E3Z-D61 2M *4 | E3Z-D81 2M *4 *5 |
| | | Standard M8 connector | | E3Z-D66 | E3Z-D86 |
| | | Pre-wired (2 m) |  1 m | E3Z-D62 2M *4 *5 | E3Z-D82 2M *4 *5 |
| | | Standard M8 connector | | E3Z-D67 | E3Z-D87 |
| | | Pre-wired (2 m) |  90±30 mm (narrow beam) | E3Z-L61 2M *4 *5 | E3Z-L81 2M *4 *5 |
| | | Standard M8 connector | | E3Z-L66 | E3Z-L86 |
| Distance-settable Refer to E3Z-LS . |  | Pre-wired (2 m) |  20 to 40 mm (BGS min setting)  20 to 200 mm (BGS max setting) | E3Z-LS61 2M *4 | E3Z-LS81 2M *4 |
| | | Standard M8 Connector | | E3Z-LS66 | E3Z-LS86 |
| | | Pre-wired (2 m) |  2 to 20 mm (BGS min setting)  2 to 80 mm (BGS max setting) | E3Z-LS63 2M | E3Z-LS83 2M *5 |
| | | Standard M8 connector | | E3Z-LS68 | E3Z-LS88 |
| Slit-type Through-beam Refer to E3Z-G . |  | 1 axis |  25 mm | E3Z-G61 2M *4 *5 | E3Z-G81 2M *4 *5 |
| | | 2 axes | | E3Z-G62 2M *4 | E3Z-G82 2M *4 |
| | | 1 axis | | E3Z-G61-M3J | E3Z-G81-M3J |
| | | 2 axes | | E3Z-G62-M3J | E3Z-G82-M3J |
| Limited-reflective for transparent glasses |  | Pre-wired (2 m) |  30±20 mm | E3Z-L63 2M | E3Z-L83 2M |
| | | Standard M8 connector | | E3Z-L68 | E3Z-J88 |
| Retro-reflective with- out MSR function for clear, plastic bottles |  | Pre-wired (2 m) |  500 mm (80 mm) | E3Z-B61 2M | E3Z-B81 2M *4 |
| | | Standard M8 connector | | E3Z-B66 | E3Z-B86 |
| | | Pre-wired (2 m) |  2 m (500 mm) | E3Z-B62 2M *4 | E3Z-B82 2M *4 |
| | | Standard M8 connector | | E3Z-B67 | E3Z-B87 |

*1. The Reflector is sold separately. Select the Reflector model most suited to the application.

*2. The sensing distance specified is possible when the E39-R1S is used. Values in parentheses indicate the minimum required distance between the Sensor and Reflector.

*3. Through-beam Sensors are normally sold in sets that include both the Emitter and Receiver.

*4. M12 Standard Pre-wired Connector Models are also available.

When ordering, add "-M1J 0.3M" to the end of the model number (e.g., E3Z-T61-M1J 0.3M).

The cable is 0.3 m long.

*5. M12 Pre-wired Smartclick Connector Models are also available.

When ordering, add "-M1TJ 0.3M" to the end of the model number (e.g., E3Z-T61-M1TJ 0.3M).

The cable is 0.3 m long.

Oil-resistive Sensors [Refer to Dimensions on page 14.]

Red light Infrared light

| Sensing method | Appearance | Connection method | Sensing distance | Model | | |
|---|------------|------------------------|------------------|---|---|--------------------------|
| | | | | NPN output | PNP output | |
| Through-beam (Emitter + Receiver) *3 | | Pre-wired (2 m) | | E3Z-T61K 2M *4 Emitter E3Z-T61K-L 2M Receiver E3Z-T61K-D 2M | E3Z-T81K 2M *4 Emitter E3Z-T81K-L 2M Receiver E3Z-T81K-D 2M | |
| | | Pre-wired M8 connector | | E3Z-T61K-M3J 0.3M Emitter E3Z-T61K-L-M3J 2M Receiver E3Z-T61K-D-M3J 2M | E3Z-T81K-M3J 0.3M Emitter E3Z-T81K-L-M3J 2M Receiver E3Z-T81K-D-M3J 2M | |
| Retro-reflective with MSR function | | Pre-wired (2 m) | | E3Z-R61K 2M *4 | E3Z-R81K 2M | |
| | | Pre-wired M8 connector | | E3Z-R61K-M3J 0.3M | E3Z-R81K-M3J 0.3M | |
| Diffuse-reflective | | Pre-wired (2 m) | | E3Z-D61K 2M *4 | E3Z-D81K 2M | |
| | | Pre-wired M8 connector | | E3Z-D61K-M3J 0.3M | E3Z-D81K-M3J 0.3M | |
| | | Pre-wired (2 m) | | | E3Z-D62K 2M *4 | E3Z-D82K 2M |
| | | Pre-wired M8 connector | | | E3Z-D62K-M3J 0.3M | E3Z-D82K-M3J 0.3M |

- *1. The Reflector is sold separately. Select the Reflector model most suited to the application.
- *2. The sensing distance specified is possible when the E39-R1S is used. Values in parentheses indicate the minimum required distance between the Sensor and Reflector.
- *3. Through-beam Sensors are normally sold in sets that include both the Emitter and Receiver.
- *4. M12 Standard Pre-wired Connector Models are also available.
When ordering, add "-M1J 0.3M" to the end of the model number (e.g., E3Z-T61-M1J 0.3M).
The cable is 0.3 m long.

Accessories (Order Separately)

Slit (A Slit is not provided with Through-beam Sensors) Order a Slit separately if required. [Refer to Dimensions on page 16.]

| Slit width | Sensing distance | | Minimum detectable object (Reference value) | Model | Contents |
|-------------|------------------|----------|--|-----------------|---|
| | E3Z-T□□ | E3Z-T□□A | | | |
| 0.5-mm dia. | 50 mm | 35 mm | 0.2-mm dia. | E39-S65A | One set (contains Slits for both the Emitter and Receiver) |
| 1-mm dia. | 200 mm | 150 mm | 0.4-mm dia. | E39-S65B | |
| 2-mm dia. | 800 mm | 550 mm | 0.7-mm dia. | E39-S65C | |
| 0.5 × 10 mm | 1 m | 700 mm | 0.2-mm dia. | E39-S65D | |
| 1 × 10 mm | 2.2 m | 1.5 m | 0.5-mm dia. | E39-S65E | |
| 2 × 10 mm | 5 m | 3.5 m | 0.8-mm dia. | E39-S65F | |

Reflectors (Reflector required for Retroreflective Sensors) A Reflector is not provided with the Sensor. Be sure to order a Reflector separately.
[Refer to Dimensions on E39-L/E39-S/E39-R]

| Name | Sensing distance * | | | | | Model | Quantity | Remarks |
|------------------------|--|--|--------------|----------------|--------------|----------------|----------|---|
| | E3Z-R | | E3Z-R□K | E3Z-B□1/-B□6 | E3Z-B□2/-B□7 | | | |
| | Rated value (sensing distance of 15 m) | Reference value (sensing distance of 10 m) | Rated value | Rated value | Rated value | | | |
| Reflector | 3 m (100 mm) | --- | 2 m (100 mm) | --- | --- | E39-R1 | 1 | <ul style="list-style-type: none"> • Retro-reflective models are not provided with Reflectors. • The MSR function is enabled. |
| | 4 m (100 mm) | --- | 3 m (150 mm) | 500 mm (80 mm) | 2 m (500 mm) | E39-R1S | 1 | |
| | --- | 5 m (100 mm) | --- | --- | --- | E39-R2 | 1 | |
| | --- | 2.5 m (100 mm) | --- | --- | --- | E39-R9 | 1 | |
| | --- | 3.5 m (100 mm) | --- | --- | --- | E39-R10 | 1 | |
| Fog Preventive Coating | --- | 3 m (100 mm) | --- | 500 mm (80 mm) | 2 m (500 mm) | E39-R1K | 1 | |
| Small Reflector | --- | 1.5 m (50 mm) | --- | --- | --- | E39-R3 | 1 | |
| Tape Reflector | --- | 700 mm (150 mm) | --- | --- | --- | E39-RS1 | 1 | |
| | --- | 1.1 m (150 mm) | --- | --- | --- | E39-RS2 | 1 | |
| | --- | 1.4 m (150 mm) | --- | --- | --- | E39-RS3 | 1 | |

Note: 1. If you use the Reflector at any distance other than the rated distance, make sure that the stability indicator lights properly when you install the Sensor.
2. Refer to Reflectors on E39-L/E39-S/E39-R for details.

* Values in parentheses indicates the minimum required distance between the Sensor and Reflector.









Mutual Interference Protection Filter A Filter is not provided with the Sensor (for the through-beam E3Z-T□□A). Order a Filter separately if required.

| Sensing distance | Appearance/Dimensions | Model | Quantity | Remarks |
|------------------|-----------------------|----------------|---|--|
| 3 m | | E39-E11 | Two sets each for the Emitter and Receiver (total of four pieces) | Can be used with the E3Z-T□□A Through-beam models. The arrow indicates the direction of polarized light. Mutual interference can be prevented by altering the direction of polarized light from or to adjacent Emitters and Receivers. |

Note: The polarization directions of the Filters are offset by 90° to prevent interference. When you install the Emitter and Receiver, install them at the same angle to maintain this offset.

Mounting Brackets A Mounting Bracket is not enclosed with the Sensor. Order a Mounting Bracket separately if required.

[Refer to *Dimensions on E39-L/E39-S/E39-R*]

| Appearance | Model (material) | Quantity | Remarks | Appearance | Model (material) | Quantity | Remarks |
|---|----------------------|----------|-------------------------------------|---|----------------------|----------|--|
|  | E39-L153 (SUS304) *1 | 1 | Mounting Brackets |  | E39-L98 (SUS304) *2 | 1 | Metal Protective Cover Bracket |
|  | E39-L104 (SUS304) *1 | 1 | |  | E39-L150 (SUS304) | 1 | (Sensor adjuster) |
|  | E39-L43 (SUS304) *2 | 1 | Horizontal Mounting Brackets |  | E39-L151 (SUS304) | 1 | Easily mounted to the aluminum frame rails of conveyors and easily adjusted. |
|  | E39-L142 (SUS304) *2 | 1 | Horizontal Protective Cover Bracket | | | | For left to right adjustment |
|  | E39-L44 (SUS304) | 1 | Rear Mounting Bracket |  | E39-L144 (SUS304) *2 | 1 | Compact Protective Cover Bracket (For E3Z only) |

Note: 1. When using Through-beam models, order one bracket for the Receiver and one for the Emitter.

2. Refer to *Mounting Brackets on E39-L/E39-S/E39-R* for details.





*1. Cannot be used for Standard Connector models with mounting surface on the bottom. In that case, use Pre-wired Connector models.

*2. Cannot be used for Standard Connector models.

Sensor I/O Connectors (Sockets on One Cable End)

(Models for Connectors and Pre-wired Connectors: A Connector is not provided with the Sensor. Be sure to order a Connector separately.)

[Refer to *Dimensions for XS3.*]

| Size | Cable | Appearance | Cable type | Model | |
|-------|-----------------------------|--|------------|--------|-----------------|
| M8 *1 | Standard | Straight *3  | 2 m | 4-wire | XS3F-M421-402-A |
| | | | 5 m | | XS3F-M421-405-A |
| | | L-shaped *3 *4  | 2 m | | XS3F-M422-402-A |
| | | | 5 m | | XS3F-M422-405-A |
| M8 | PUR (Polyurethane) cable *2 | Straight *3  | 2 m | 4-wire | XS3F-M421-402-L |
| | | | 5 m | | XS3F-M421-405-L |
| | | L-shaped *3 *4  | 2 m | | XS3F-M422-402-L |
| | | | 5 m | | XS3F-M422-405-L |

Note: When using Through-beam models, order one connector for the Receiver and one for the Emitter.

*1. Refer to *Introduction to Sensor I/O Connectors/Sensor Controllers* for details.

*2. The Sensor can be used in low-temperature environments (-25°C to -40°C). Do not use the Sensor in locations that are subject to oil.

*3. The connector will not rotate after connecting.

*4. The cable is fixed at an angle of 180° from the sensor emitter/receiver surface.

Ratings and Specifications

| Item | Sensing method | | Through-beam | | | Retro-reflective with MSR function | Diffuse-reflective | | (Narrow-beam Models) | |
|---|-----------------------|----------------|---|-----------------------------|-----------------------------|---|--|---------------------------------------|--|---------|
| | NPN output | Pre-wired | E3Z-T61 | E3Z-T62 | E3Z-T61A | E3Z-R61 | E3Z-D61 | E3Z-D62 | E3Z-L61 | |
| Model | Connector (M8) | Pre-wired | E3Z-T66 | E3Z-T67 | E3Z-T66A | E3Z-R66 | E3Z-D66 | E3Z-D67 | E3Z-L66 | |
| | | PNP output | Pre-wired | E3Z-T81 | E3Z-T82 | E3Z-T81A | E3Z-R81 | E3Z-D81 | E3Z-D82 | E3Z-L81 |
| Item | Connector (M8) | Pre-wired | E3Z-T86 | E3Z-T87 | E3Z-T86A | E3Z-R86 | E3Z-D86 | E3Z-D87 | E3Z-L86 | |
| | | Connector (M8) | E3Z-T86 | E3Z-T87 | E3Z-T86A | E3Z-R86 | E3Z-D86 | E3Z-D87 | E3Z-L86 | |
| Sensing distance | | | 15 m | 30 m | 10 m | 4 m (100 mm) *1 (when using E39-R1S) 3 m (100 mm) *1 (when using E39-R1) | 100 mm (white paper: 100 × 100 mm) | 1 m (white paper: 300 × 300 mm) | 90 + 30 mm (white paper, 100 x 100 mm) | |
| Spot diameter (reference value) | | | --- | | | | | | (2.5 dia. and sensing distance of 90 mm) | |
| Standard sensing object | | | Opaque: 12-mm dia. min. | | | Opaque: 75-mm dia. min. | | --- | | |
| Minimum detectable object (reference value) | | | --- | | | | | | 0.1 mm (copper wire) | |
| Differential travel | | | --- | | | | 20% max. of setting distance | | Refer to <i>Engineering data</i> on page 8. | |
| Directional angle | | | Both emitter and receiver: 3 to 15° | | | 2 to 10° | | --- | | |
| Light source (wavelength) | | | Infrared LED (870 nm) | | Red LED (660 nm) | Red LED (660 nm) | Infrared LED (860 nm) | | Red LED (650 nm) | |
| Current consumption | | | 35 mA max. (Emitter: 15 mA max., Receiver: 20 mA max.) | | | 30 mA max. | | | | |
| Protection circuits | | | Reversed power supply polarity protection, Output short-circuit protection, and Reversed output polarity protection | | | Reversed power supply polarity protection, Output short-circuit protection, Mutual interference prevention, and Reversed output polarity protection | | | | |
| Response time | | | Operate or reset: 1 ms max. | Operate or reset: 2 ms max. | Operate or reset: 1 ms max. | | | | | |
| Degree of protection | | | IEC, IP67 | | | | | | | |
| Connection method | | | Pre-wired cable (standard length: 2 m and 0.5 m), Connector (M8) | | | | | | | |
| Weight (packed state) | Pre-wired cable (2 m) | | Approx. 120 g | | | Approx. 65 g | | | | |
| | Connector | | Approx. 30 g | | | Approx. 20 g | | | | |
| Material | Case | | PBT (polybutylene terephthalate) | | | | | | | |
| | Lens | | Modified polyarylate | | | Methacrylic resin | Modified polyarylate | | | |

| Item | Sensing method | | Retro-reflective for clear, plastic bottles (without MSR function) | | | |
|---------------------------|-----------------------|----------------|---|------------------------|--|------------------------|
| | NPN output | PNP output | E3Z-B61 | E3Z-B66 | E3Z-B62 | E3Z-B67 |
| Model | Pre-wired | Pre-wired | E3Z-B81 | E3Z-B86 | E3Z-B82 | E3Z-B87 |
| | | Connector (M8) | E3Z-B81 | E3Z-B86 | E3Z-B82 | E3Z-B87 |
| Sensing distance | | | 500 mm (80 mm) *1 (using E39-R1S) | | 2 m (500 mm) *1 *2 (using E39-R1S) | |
| Standard sensing object | | | 500-ml (65-mm dia.) transparent round plastic bottles | | | |
| Light source (wavelength) | | | Red LED (660 nm) | | | |
| Current consumption | | | 30 mA max. | | | |
| Protection circuits | | | Reversed power supply polarity protection, Output short-circuit protection, Mutual interference prevention, and Reversed output polarity protection | | | |
| Response time | | | Operate or reset: 1 ms max. | | | |
| Degree of protection | | | IEC, IP67 | | | |
| Connection method | | | Pre-wired cable (standard length: 2 m and 0.5 m) | Connector (M8, 4 pins) | Pre-wired cable (standard length: 2 m and 0.5 m) | Connector (M8, 4 pins) |
| Weight (packed state) | Pre-wired cable (2 m) | | Approx. 65 g | | | |
| | Standard Connector | | Approx. 20 g | | | |
| Material | Case | | PBT (polybutylene terephthalate) | | | |
| | Lens | | Modified polyarylate | | | |

*1. Values in parentheses indicate the minimum required distances between the Sensors and Reflectors.

*2. Plastic bottles must pass with the minimum clearance of 500 mm.

| Item | Sensing method | | Transparent glass Limited-reflective (for transparent object detection) | |
|--|------------------------------|---|--|--------------|
| | Model | NPN output | E3Z-L63 | E3Z-L68 |
| | | PNP output | E3Z-L83 | E3Z-L88 |
| Sensing distance | | 30±20 mm (transparent glasses 100 × 100 mm) | | |
| Spot diameter (reference value) | | 2-mm dia. min. (at sensing distance of 30 mm) | | |
| Minimum detectable object (reference value) | | 0.1 mm dia. (copper wire) | | |
| Light source (wavelength) | | Red LED (660 nm) | | |
| Current consumption | | 30 mA max. | | |
| Protection circuits | | Power supply reverse polarity protection, Output short-circuit protection, Mutual interference prevention, Reverse output polarity protection | | |
| Response time | | Operate or reset: 1 ms max. | | |
| Degree of protection | | IEC, IP67 | | |
| Connection method | | Pre-wired (standard length: 2 m) | | M8 connector |
| Weight (packed state) | Pre-wired cable (2 m) | Approx. 65 g | | |
| | Standard Connector | Approx. 20 g | | |
| Material | Case | PBT (polybutylene terephthalate) | | |
| | Lens | Modified polyarylate | | |

Oil-resistant

| Item | Model | Sensing method | | Through-beam | Retro-reflective | Diffuse-reflective | |
|----------------------------------|-------------------------------|------------------------|------------------|---|--|--|---------------------------------------|
| | | NPN out-put | Pre-wired Models | E3Z-T61K | E3Z-R61K | E3Z-D61K | E3Z-D62K |
| | | M8 Pre-wired connector | E3Z-T61K-M3J | E3Z-R61K-M3J | E3Z-D61K-M3J | E3Z-D62K-M3J | |
| | | PNP out-put | Pre-wired Models | E3Z-T81K | E3Z-R81K | E3Z-D81K | E3Z-D82K |
| | | M8 Pre-wired connector | E3Z-T81K-M3J | E3Z-R81K-M3J | E3Z-D81K-M3J | E3Z-D82K-M3J | |
| Sensing distance | | | | 15 m | 3 m (150 mm) * (when using E39-R1S) 2 m (100 mm) * (when using E39-R1) | 100 mm (white paper: 100 × 100 mm) | 1 m (white paper: 300 × 300 mm) |
| Standard sensing object | | | | Opaque: 12-mm dia. min. | Opaque: 75-mm dia. min. | --- | |
| Differential travel | | | | --- | | 20% max. of setting distance | |
| Directional angle | | | | Both emitter and receiver: 3 to 15° | 2 to 10° | --- | |
| Light source (wavelength) | | | | Infrared LED (870 nm) | Red LED (660 nm) | Infrared LED (860 nm) | |
| Current consumption | | | | 35 mA max. (Emitter: 15 mA max., Receiver: 20 mA max.) | 30 mA max. | | |
| Protection circuits | | | | Reversed power supply polarity protection, Output short-circuit protection, and Reversed output po- larity protection | Reversed power supply polarity protection, Output short-circuit protection, Mutual in- terference prevention, and Reversed output polarity protection | | |
| Response time | | | | Operate or reset: 1 ms max. | | | |
| Degree of protection | | | | IP67 (IEC), Oil resistant models: IP67 (IEC) (in-house standards: oilproof), excluding cables and connectors | | | |
| Connection method | | | | Pre-wired cable (standard length: 2 m), M8 Pre-wired Connector | | | |
| Weight (packed state) | Pre-wired cable (2 m) | | | Approx. 120 g | Approx. 65 g | | |
| | Connector (M8, 4 pins) | | | Approx. 50 g | Approx. 30 g | | |
| Material | Case | | | PBT (polybutylene terephthalate) | | | |
| | Lens | | | Modified polyarylate | Methacrylic resin | Modified polyarylate | |

* Values in parentheses indicate the minimum required distance between the Sensor and Reflector.

Common

| | |
|---|---|
| Power supply voltage | 12 to 24 VDC±10%, ripple (p-p): 10% max. |
| Control output | Load power supply voltage: 26.4 VDC max., Load current: 100 mA max. Residual voltage: Load current of less than 10 mA: 1 V max. Load current of 10 to 100 mA: 2 V max. Open collector output (NPN/PNP depending on model) Light-ON/Dark-ON selectable |
| Sensitivity adjustment | One-turn adjuster |
| Ambient illumination (Receiver side) | Incandescent lamp: 3,000 lx max. Sunlight: 10,000 lx max. |
| Ambient temperature range | Operating: -25 to 55°C, Some connector models: -40°C to 55°C * (with no icing or condensation) Storage: -40 to 70°C (with no icing or condensation) |
| Ambient humidity range | Operating: 35% to 85%, Storage: 35% to 95% (with no condensation) |
| Insulation resistance | 20 MΩ min. at 500 VDC |
| Dielectric strength | 1,000 VAC, 50/60 Hz for 1 min |
| Vibration resistance | Destruction: 10 to 55 Hz, 1.5 mm double amplitude for 2 hours each in X, Y, and Z directions |
| Shock resistance | Destruction: 500 m/s ² 3 times each in X, Y, and Z directions |
| Indicator | Operation indicator (orange) Stability indicator (green) Through-beam Emitter has power indicator (orange) only. |
| Accessories | Instruction manual (Neither Reflectors nor Mounting Brackets are provided with any of the above models.) |

* The ambient temperature range during operation for connector models depends on the model. For the E3Z-T66/T86/R66/R86, the range is -40°C to 55°C. For the E3Z-D66/D86/D67/D87, the range is -30°C to 55°C. For other connector models, the range is -25°C to -55°C.
The sensing distance for Retro-reflective Models (E3Z-R66/R86) between -40°C to -25°C, however, will be as follows (not the values in the table):
With E39-R1S: 3 m (100 mm), With E39-R1: 2 m (100 mm).
Also, use the XS3F-M42□-4□□-L Sensor I/O Connector (PUR cable) for applications between -25°C to -40°C. (Refer to page 4.)

Engineering Data (Reference Value)

Parallel Operating Range

Through-beam Models

E3Z-T□1(T□6)

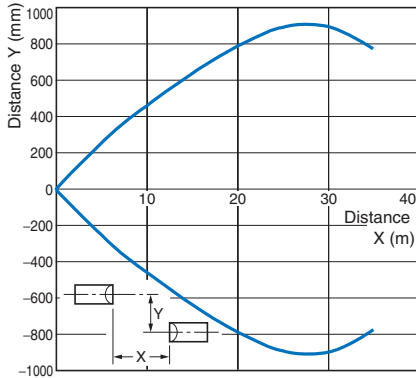

Through-beam Models

E3Z-T□A

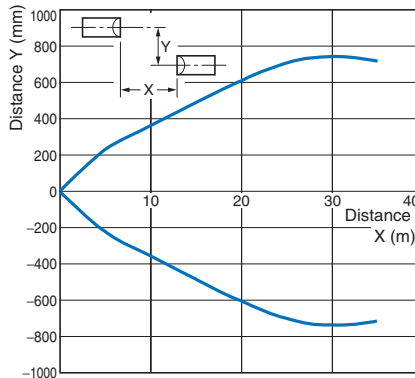

Through-beam Models

E3Z-T□2(T□7)

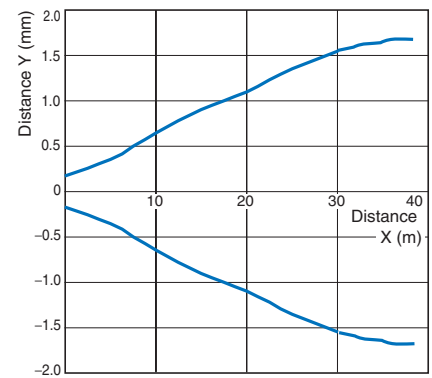

Through-beam Models

E3Z-T□1(T□6) and Slit
(A Slit is mounted to the Emitter and Receiver.)

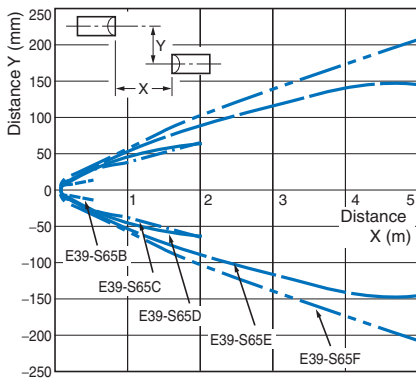

Through-beam Models

E3Z-T□A and Slit
(A Slit is mounted to the Emitter and Receiver.)

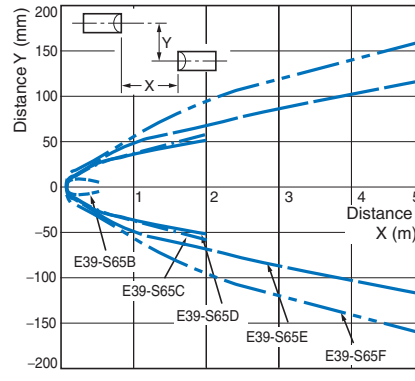

Retro-reflective Models

E3Z-R□1(R□6) and Reflector

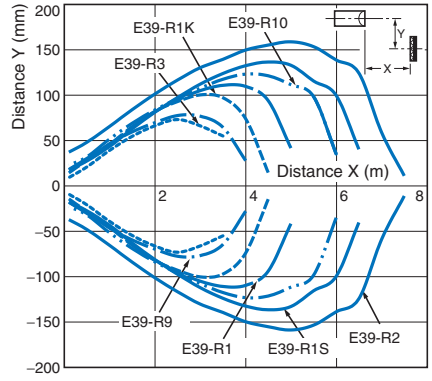

E3Z-B□1/B□6 + E39-R1S Reflector
(Order Separately)

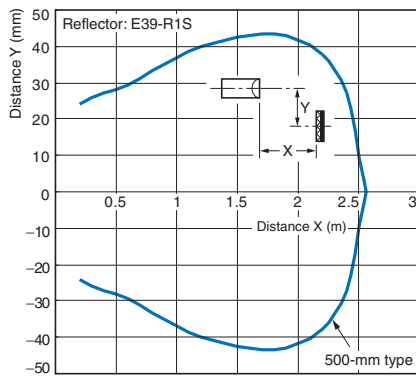

E3Z-B□2/B□7 + E39-R1S Reflector
(Order Separately)

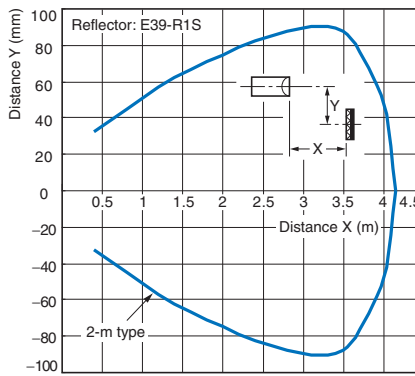

Operating Range

Diffuse-reflective Models

E3Z-D□1(D□6)

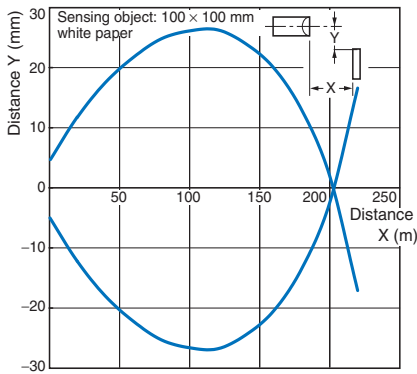

Diffuse-reflective Models

E3Z-D□2(D□7)

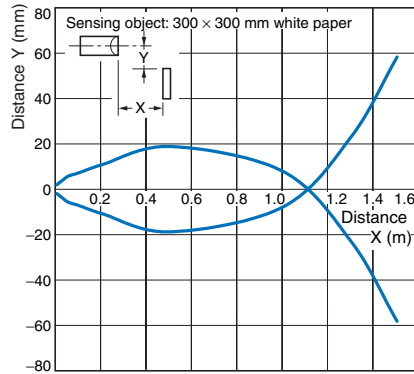

Narrow-beam Reflective Models

E3Z-L□1(L□6)

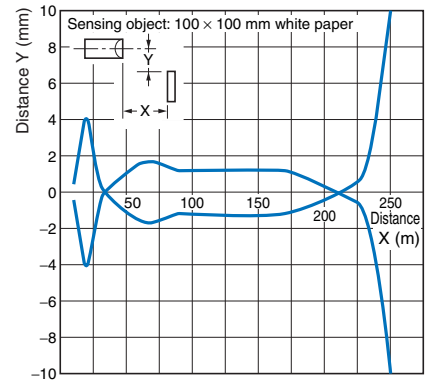

Excess Gain vs. Set Distance

Through-beam Models

E3Z-T□1(T□6)/-T□A/-T□2(T□7)

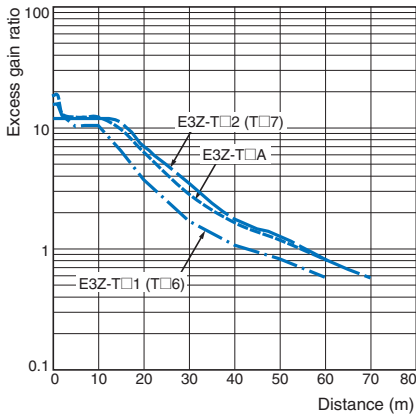

Retro-reflective Models

E3Z-R□1(R□6) and Reflector

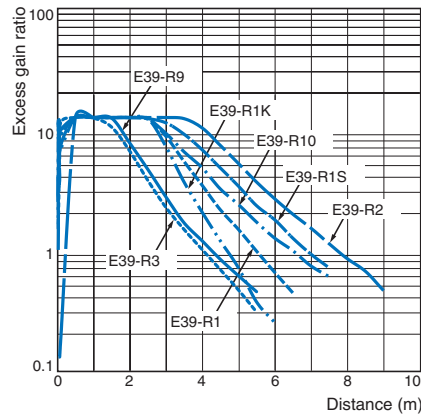

Diffuse-reflective Models

E3Z-D□1(D□6)

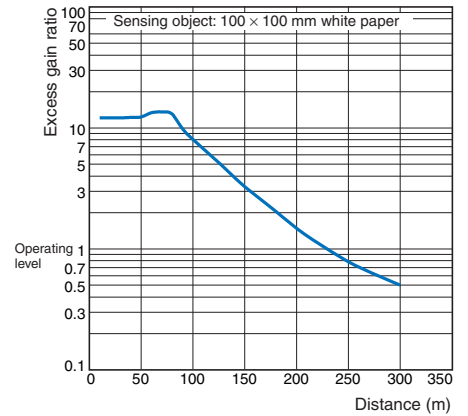

Diffuse-reflective Models

E3Z-D□2(D□7)

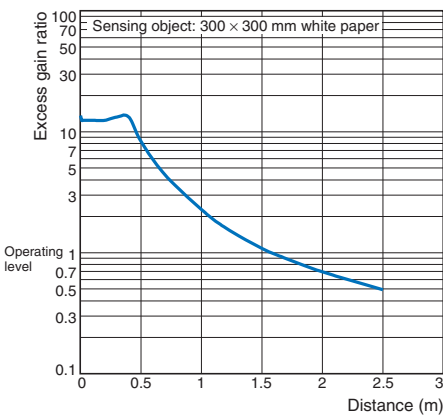

Narrow-beam Reflective Models

E3Z-L□1(L□6)

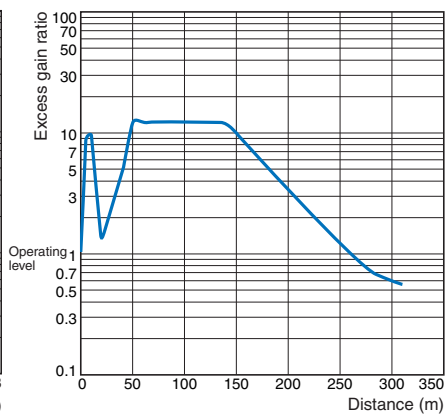

Limited reflective Models

E3Z-L□3(L□8)

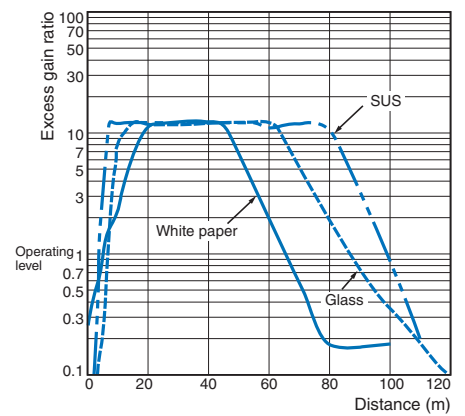

Excess Gain vs. Set Distance

E3Z-B□1/B□6 + E39-R1S Reflector (Order Separately)

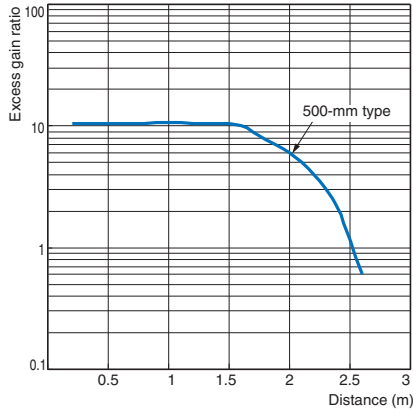

E3Z-B□2/B□7 + E39-R1S Reflector (Order Separately)

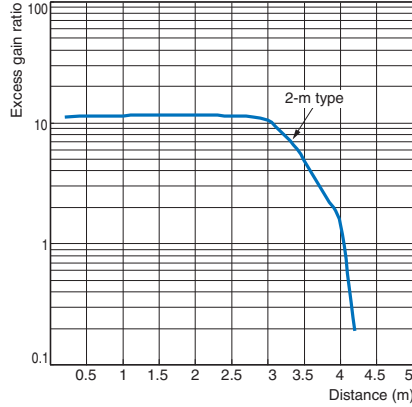

Sensing Object Size vs. Sensing Distance

Diffuse-reflective Models

E3Z-D□1(D□6)

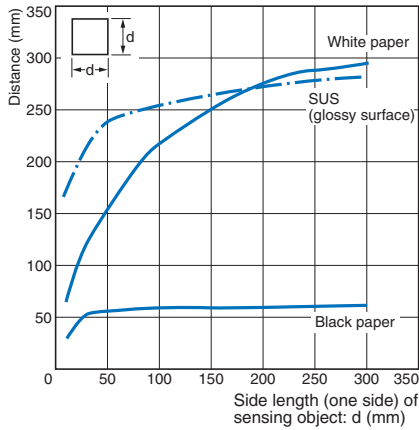

Diffuse-reflective Models

E3Z-D□2(D□7)

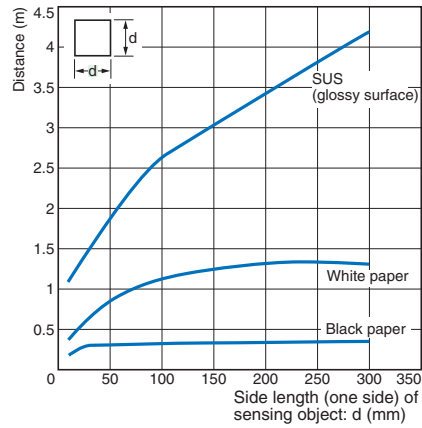

Narrow-beam Reflective Models

E3Z-L□1(L□6)

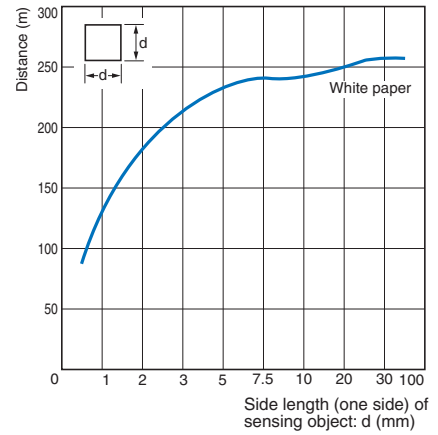

Spot Diameter vs. Sensing Distance

Narrow-beam Reflective Models

E3Z-L□1(L□6)

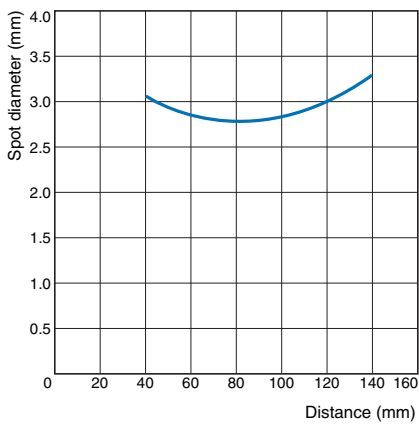

Differential Travel vs. Sensing Distance

Narrow-beam Reflective Models

E3Z-L□1(L□6)

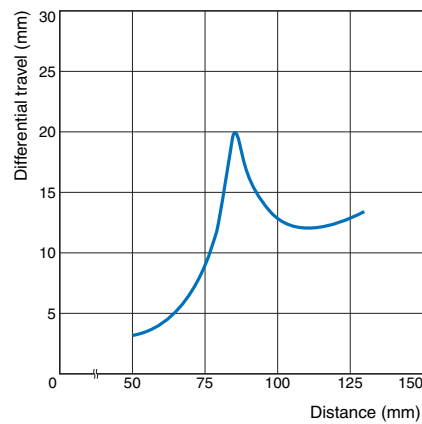

I/O Circuit Diagrams

NPN Output

| Model* | Operation mode | Timing charts | Operation selector | Output circuit |
|--|----------------------|--|--------------------|--|
| E3Z-T61(K) E3Z-T66 E3Z-T62 E3Z-T67 E3Z-T61A E3Z-T66A E3Z-R61(K) E3Z-R66 E3Z-D61(K) E3Z-D66 E3Z-D62(K) E3Z-D67 E3Z-L61 E3Z-L66 E3Z-B61 E3Z-B66 E3Z-B62 E3Z-B67 E3Z-L63 E3Z-L68 | Light-ON | Incident light No incident light Operation indicator (orange) ON OFF Output transistor ON OFF Load Operate (e.g., relay) Reset (Between brown (1) and black (4) leads) | L side (LIGHT ON) | Through-beam Receivers, Retro-reflective Models, Diffuse-reflective Models, Limited reflective Models. <p>Connector Pin Arrangement</p> <p>Pin 2 is not used.</p> |
| | Dark-ON | Incident light No incident light Operation indicator (orange) ON OFF Output transistor ON OFF Load Operate (e.g., relay) Reset (Between brown (1) and black (4) leads) | D side (DARK ON) | Through-beam Receiver, Retro-reflective Models, Diffuse-reflective Models, Limited reflective Models. <p>Connector Pin Arrangement</p> <p>Pin 2 is not used.</p> |
| E3Z-B61 E3Z-B66 E3Z-B62 E3Z-B67 E3Z-L63 E3Z-L68 | Through-beam Emitter | <p>Connector Pin Arrangement</p> <p>Pins 2 and 4 are not used.</p> | | |

PNP Output

| Model* | Operation mode | Timing charts | Operation selector | Output circuit |
|--|----------------------|---|--------------------|--|
| E3Z-T81(K) E3Z-T86 E3Z-T82 E3Z-T87 E3Z-T81A E3Z-T86A E3Z-R81(K) E3Z-R86 E3Z-D81(K) E3Z-D86 E3Z-D82(K) E3Z-D87 E3Z-L81 E3Z-L86 E3Z-B81 E3Z-B86 E3Z-B82 E3Z-B87 E3Z-L83 E3Z-L88 | Light-ON | Incident light No incident light Operation indicator (orange) ON OFF Output transistor ON OFF Load Operate (e.g., relay) Reset (Between blue (3) and black (4) leads) | L side (LIGHT ON) | Through-beam Receivers, Retro-reflective Models, Diffuse-reflective Models, Limited reflective Models. <p>Connector Pin Arrangement</p> <p>Pin 2 is not used.</p> |
| | Dark-ON | Incident light No incident light Operation indicator (orange) ON OFF Output transistor ON OFF Load Operate (e.g., relay) Reset (Between blue (3) and black (4) leads) | D side (DARK ON) | Through-beam Receiver, Retro-reflective Models, Diffuse-reflective Models, Limited reflective Models. <p>Connector Pin Arrangement</p> <p>Pin 2 is not used.</p> |
| E3Z-B81 E3Z-B86 E3Z-B82 E3Z-B87 E3Z-L83 E3Z-L88 | Through-beam Emitter | <p>Connector Pin Arrangement</p> <p>Pins 2 and 4 are not used.</p> | | |

* Models numbers for Through-beam Sensors (E3Z-T□□) are for sets that include both the Emitter and Receiver. The model number of the Emitter is expressed by adding "-L" to the set model number (example: E3Z-T61-L 2M), the model number of the Receiver, by adding "-D" (example: E3Z-T61-D 2M.) Refer to *Ordering Information* to confirm model numbers for Emitter and Receivers.

Plugs (Sensor I/O Connectors)

M8 connector

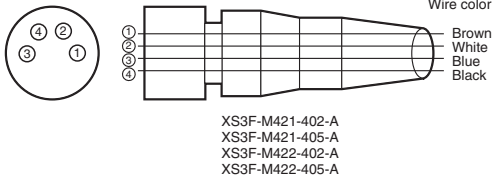

Pin arrangement

| Classification | Wire color | Connector pin No. | Application |
|----------------|------------|-------------------|--------------------|
| DC | Brown | 1 | Power supply (+V) |
| | White | 2 | - |
| | Blue | 3 | Power supply (0 V) |
| | Black | 4 | Output |

Note: Pin 2 is not used.

Nomenclature

Through-beam Models

E3Z-T□□ (Receiver)

E3Z-T□□A (Receiver)

Retro-reflective Models

E3Z-R□□

E3Z-B□□

Diffuse-reflective Models

E3Z-D□□

Narrow-beam Reflective Models

E3Z-L□□

Limited reflective Models

E3Z-L□□

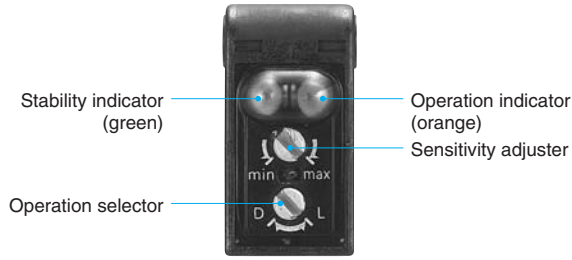

Safety Precautions

Refer to *Warranty and Limitations of Liability*.

⚠ WARNING

This product is not designed or rated for ensuring safety of persons either directly or indirectly. Do not use it for such purposes.



Precautions for Correct Use

Do not use the product in atmospheres or environments that exceed product ratings.

● Wiring

M8 Metal Connector

- Be sure to connect or disconnect the metal connector after turning OFF the Sensor.
- Hold the connector cover to connect or disconnect the metal connector.
- Secure the connector cover by hand. Do not use any pliers, otherwise the connector may be damaged.
- The proper tightening torque range is between 0.3 and 0.4 N·m. Be sure to tighten the connector securely, otherwise the specified degree of protection may not be maintained or the connector may be disconnected due to vibration.

● Mounting

Sensor Mounting

Use M3 screws to mount the sensor and tighten each screw to a maximum torque of 0.53 N·m.

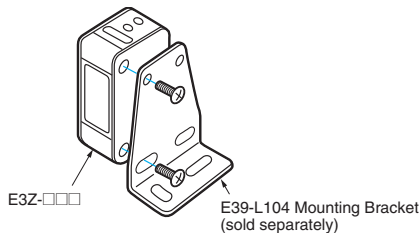

● Oil-resistant Models

Oil Resistance

- Although the E3Z-□□□K Sensors have oil-resistant specifications, performance may be affected by certain types of oil. Refer to the following table.
- E3Z-□□□K Sensors are tested for resistance to the oils given in the following table. Refer to the information in the table when deciding which type of oil to use.

| Test oil classification | Product name | Kinematic viscosity (mm ² /s) at 40°C | pH |
|-------------------------------|--|--|----------|
| Lubricant | Velocity No.3 (manufactured by Exxon Mobil) | 2.02 | --- |
| Water insoluble machining oil | Yushiron Oil No.2 ac (manufactured by Yushiro Chemical Industry Co., Ltd.) | Less than 10 | --- |
| | Yushironken EC50T-3 (manufactured by Yushiro Chemical Industry Co., Ltd.) | | 7 to 9.5 |
| Water soluble machining oil | Yushiron Lubic HWC68 (manufactured by Yushiro Chemical Industry Co., Ltd.) | --- | 7 to 9.9 |
| | Gryton 1700D (manufactured by Toho Chemical Industry Co., Ltd.) | | 7 to 9.2 |
| | Yushironken S50N (manufactured by Yushiro Chemical Industry Co., Ltd.) | | 7 to 9.8 |

Note: 1. The E3Z maintained a minimum insulation resistance of 100 MΩ after it was dipped in all the above oils for 240 hours.

2. When using the Sensors in environments subject to oils other than those listed above, use the figures for kinematic viscosity and pH from the table as general guidelines. Additives and other substances contained in oils may affect the E3Z. Be sure to consider this before use.

Dimensions

Tolerance class IT16 applies to dimensions in this data sheet unless otherwise specified.

Sensors

Through-beam*

Pre-wired Models

- E3Z-T61(K)
- E3Z-T81(K)
- E3Z-T61A
- E3Z-T81A
- E3Z-T62
- E3Z-T82

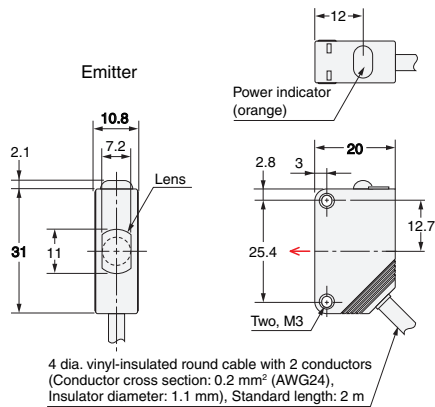

4 dia. vinyl-insulated round cable with 2 conductors
(Conductor cross section: 0.2 mm² (AWG24),
Insulator diameter: 1.1 mm), Standard length: 2 m

| Terminal No. | Specifications |
|--------------|----------------|
| 1 | +V |
| 2 | --- |
| 3 | 0V |
| 4 | --- |

Pins 2 and 4 are not used.

M8 Pre-wired Connector
(E3Z-T□□K-M3J)

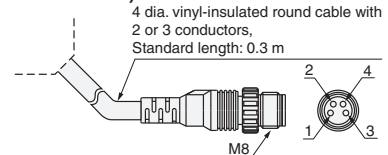

* The Emitter cable has two conductors and the Receiver cable has three conductors.

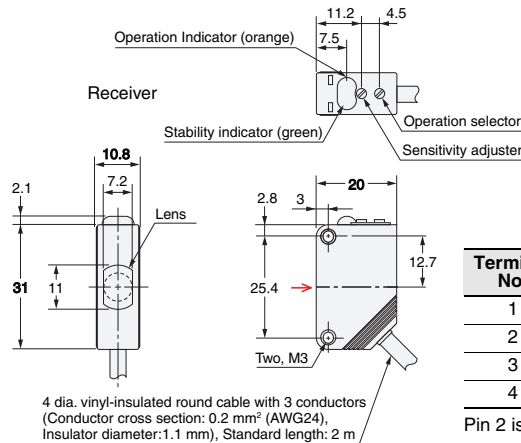

4 dia. vinyl-insulated round cable with 3 conductors
(Conductor cross section: 0.2 mm² (AWG24),
Insulator diameter: 1.1 mm), Standard length: 2 m

| Terminal No. | Specifications |
|--------------|----------------|
| 1 | +V |
| 2 | --- |
| 3 | 0V |
| 4 | Output |

Pin 2 is not used.

Through-beam*

Connector Models

- E3Z-T66
- E3Z-T86
- E3Z-T66A
- E3Z-T86A
- E3Z-T67
- E3Z-T87

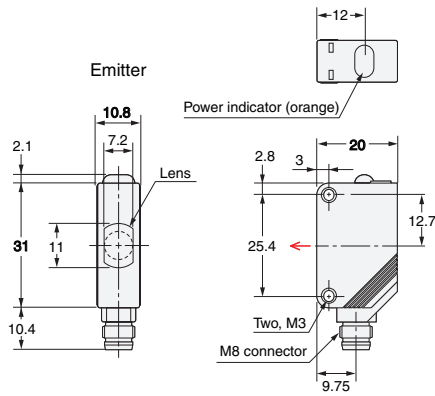

| Terminal No. | Specifications |
|--------------|----------------|
| 1 | +V |
| 2 | --- |
| 3 | 0V |
| 4 | --- |

Pins 2 and 4 are not used.

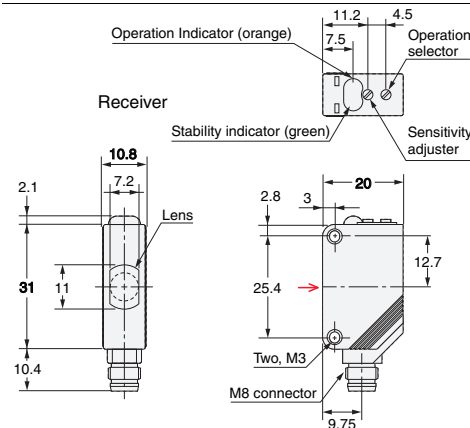

| Terminal No. | Specifications |
|--------------|----------------|
| 1 | +V |
| 2 | --- |
| 3 | 0V |
| 4 | Output |

Pin 2 is not used.

* Models numbers for Through-beam Sensors (E3Z-T□□) are for sets that include both the Emitter and Receiver. The model number of the Emitter is expressed by adding "-L" to the set model number (example: E3Z-T61-L 2M), the model number of the Receiver, by adding "-D" (example: E3Z-T61-D 2M.) Refer to *Ordering Information* to confirm model numbers for Emitter and Receivers.

Retro-reflective Models

Pre-wired Models

- E3Z-R61(K) E3Z-B61
- E3Z-R81(K) E3Z-B81
- E3Z-D61(K) E3Z-B62
- E3Z-D81(K) E3Z-B82
- E3Z-D62(K) E3Z-L63
- E3Z-D82(K) E3Z-L83
- E3Z-L61
- E3Z-L81

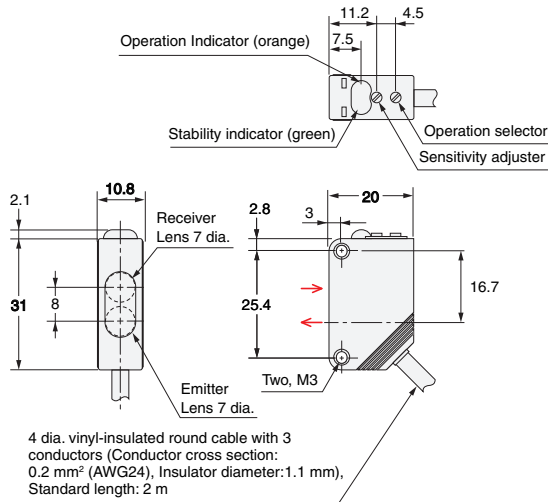

M8 Pre-wired Connector (E3Z-T□□K-M3J)

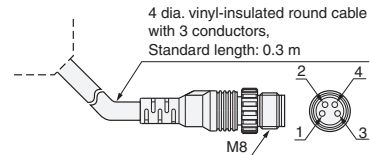

| Terminal No. | Specifications |
|--------------|----------------|
| 1 | +V |
| 2 | --- |
| 3 | 0V |
| 4 | Output |

Retro-reflective Models

Connector Models

- E3Z-R66 E3Z-B66
- E3Z-R86 E3Z-B86
- E3Z-D66 E3Z-B67
- E3Z-D86 E3Z-B87
- E3Z-D67 E3Z-L68
- E3Z-D87 E3Z-L88
- E3Z-L66
- E3Z-L86

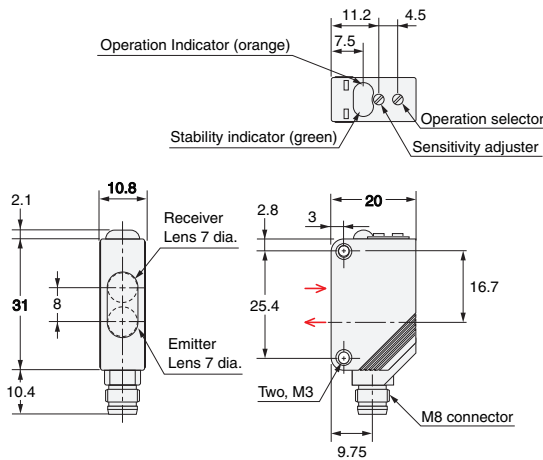

| Terminal No. | Specifications |
|--------------|----------------|
| 1 | +V |
| 2 | --- |
| 3 | 0V |
| 4 | Output |

Note: The lens for the E3Z-D□1/D□6/L□□/B□□ is red. The lens for the E3Z-D□2/D□7 is black.

Accessories (Order Separately)

Slits

E39-S65A
E39-S65B
E39-S65C

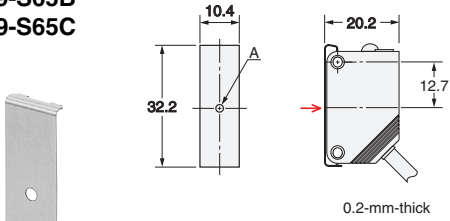

| Model | Size A | Material |
|----------|----------|------------------------|
| E39-S65A | 0.5 dia. | SUS301 stainless steel |
| E39-S65B | 1.0 dia. | |
| E39-S65C | 2.0 dia. | |

Slits

E39-S65D
E39-S65E
E39-S65F

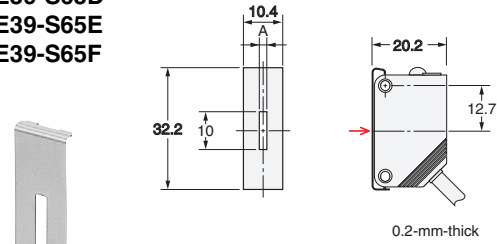

| Model | Size A | Material |
|----------|--------|------------------------|
| E39-S65D | 0.5 | SUS301 stainless steel |
| E39-S65E | 1.0 | |
| E39-S65F | 2.0 | |

Slits

E39-L44

(Mounting dimensions)

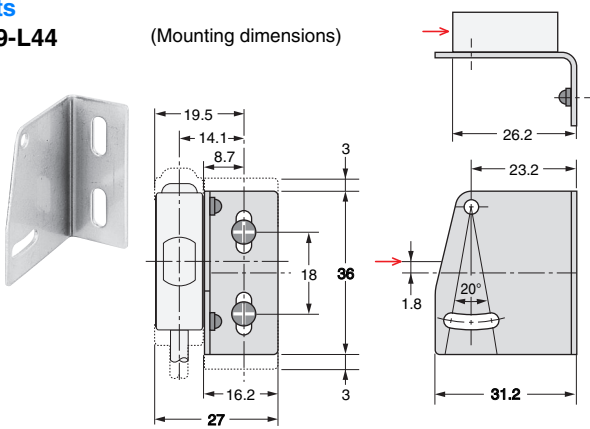

Slits

E39-L104

(Mounting dimensions)

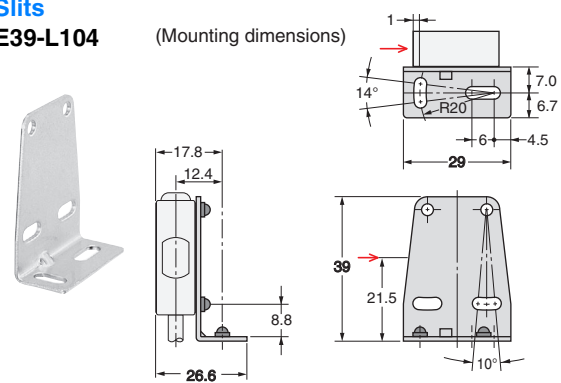

Mounting Brackets

Refer to E39-R for details.

Sensor I/O Connectors

Refer to XS3□ for details.

Terms and Conditions Agreement

Read and understand this catalog.

Please read and understand this catalog before purchasing the products. Please consult your OMRON representative if you have any questions or comments.

Warranties.

(a) Exclusive Warranty. Omron's exclusive warranty is that the Products will be free from defects in materials and workmanship for a period of twelve months from the date of sale by Omron (or such other period expressed in writing by Omron). Omron disclaims all other warranties, express or implied.

(b) Limitations. OMRON MAKES NO WARRANTY OR REPRESENTATION, EXPRESS OR IMPLIED, ABOUT NON-INFRINGEMENT, MERCHANTABILITY OR FITNESS FOR A PARTICULAR PURPOSE OF THE PRODUCTS. BUYER ACKNOWLEDGES THAT IT ALONE HAS DETERMINED THAT THE PRODUCTS WILL SUITABLY MEET THE REQUIREMENTS OF THEIR INTENDED USE.

Omron further disclaims all warranties and responsibility of any type for claims or expenses based on infringement by the Products or otherwise of any intellectual property right. (c) Buyer Remedy. Omron's sole obligation hereunder shall be, at Omron's election, to (i) replace (in the form originally shipped with Buyer responsible for labor charges for removal or replacement thereof) the non-complying Product, (ii) repair the non-complying Product, or (iii) repay or credit Buyer an amount equal to the purchase price of the non-complying Product; provided that in no event shall Omron be responsible for warranty, repair, indemnity or any other claims or expenses regarding the Products unless Omron's analysis confirms that the Products were properly handled, stored, installed and maintained and not subject to contamination, abuse, misuse or inappropriate modification. Return of any Products by Buyer must be approved in writing by Omron before shipment. Omron Companies shall not be liable for the suitability or unsuitability or the results from the use of Products in combination with any electrical or electronic components, circuits, system assemblies or any other materials or substances or environments. Any advice, recommendations or information given orally or in writing, are not to be construed as an amendment or addition to the above warranty.

See <http://www.omron.com/global/> or contact your Omron representative for published information.

Limitation on Liability; Etc.

OMRON COMPANIES SHALL NOT BE LIABLE FOR SPECIAL, INDIRECT, INCIDENTAL, OR CONSEQUENTIAL DAMAGES, LOSS OF PROFITS OR PRODUCTION OR COMMERCIAL LOSS IN ANY WAY CONNECTED WITH THE PRODUCTS, WHETHER SUCH CLAIM IS BASED IN CONTRACT, WARRANTY, NEGLIGENCE OR STRICT LIABILITY.

Further, in no event shall liability of Omron Companies exceed the individual price of the Product on which liability is asserted.

Suitability of Use.

Omron Companies shall not be responsible for conformity with any standards, codes or regulations which apply to the combination of the Product in the Buyer's application or use of the Product. At Buyer's request, Omron will provide applicable third party certification documents identifying ratings and limitations of use which apply to the Product. This information by itself is not sufficient for a complete determination of the suitability of the Product in combination with the end product, machine, system, or other application or use. Buyer shall be solely responsible for determining appropriateness of the particular Product with respect to Buyer's application, product or system. Buyer shall take application responsibility in all cases.

NEVER USE THE PRODUCT FOR AN APPLICATION INVOLVING SERIOUS RISK TO LIFE OR PROPERTY OR IN LARGE QUANTITIES WITHOUT ENSURING THAT THE SYSTEM AS A WHOLE HAS BEEN DESIGNED TO ADDRESS THE RISKS, AND THAT THE OMRON PRODUCT(S) IS PROPERLY RATED AND INSTALLED FOR THE INTENDED USE WITHIN THE OVERALL EQUIPMENT OR SYSTEM.

Programmable Products.

Omron Companies shall not be responsible for the user's programming of a programmable Product, or any consequence thereof.

Performance Data.

Data presented in Omron Company websites, catalogs and other materials is provided as a guide for the user in determining suitability and does not constitute a warranty. It may represent the result of Omron's test conditions, and the user must correlate it to actual application requirements. Actual performance is subject to the Omron's Warranty and Limitations of Liability.

Change in Specifications.

Product specifications and accessories may be changed at any time based on improvements and other reasons. It is our practice to change part numbers when published ratings or features are changed, or when significant construction changes are made. However, some specifications of the Product may be changed without any notice. When in doubt, special part numbers may be assigned to fix or establish key specifications for your application. Please consult with your Omron's representative at any time to confirm actual specifications of purchased Product.

Errors and Omissions.

Information presented by Omron Companies has been checked and is believed to be accurate; however, no responsibility is assumed for clerical, typographical or proofreading errors or omissions.