

CDCV304 140-MHz PCI-X CLOCK BUFFER

SCAS643C – SEPTEMBER 2000 REVISED AUGUST 2006

- General-Purpose and PCI-X 1:4 Clock Buffer
- Operating Frequency: 0 MHz to 140 MHz
- Low Output Skew: <100 ps
- Distributes One Clock Input to One Bank of Four Outputs
- Output Enable Control That Drives Outputs Low When OE Is Low
- Operates From Single 3.3-V Supply
- 8-Pin TSSOP Package

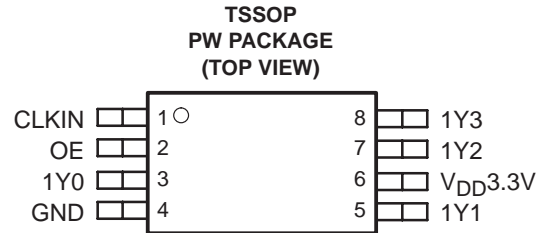

description

The CDCV304 is a high-performance, low-skew, general-purpose and PCI-X clock buffer. It distributes one input clock signal (CLKIN) to the output clocks (1Y[0:3]). It is specifically designed for use with PCI-X applications. The CDCV304 operates at 3.3 V.

The CDCV304 is characterized for operation from -40°C to 85°C for automotive and industrial applications.

FUNCTION TABLE

INPUTS		OUTPUT
CLKIN	OE	1Y (0:3)
L	L	L
H	L	L
L	H	L
H	H	H

functional block diagram

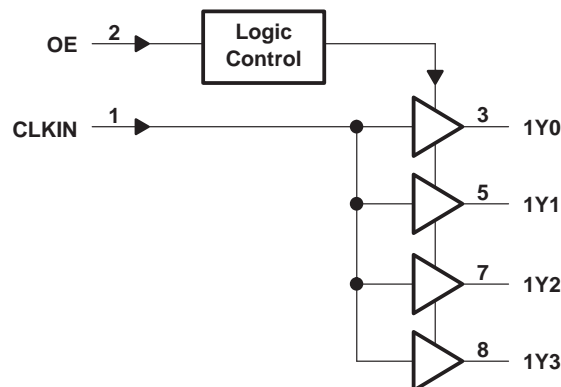

Please be aware that an important notice concerning availability, standard warranty, and use in critical applications of Texas Instruments semiconductor products and disclaimers thereto appears at the end of this data sheet.

PRODUCTION DATA information is current as of publication date. Products conform to specifications per the terms of Texas Instruments standard warranty. Production processing does not necessarily include testing of all parameters.

**TEXAS
INSTRUMENTS**

WWW.TI.COM
POST OFFICE BOX 1443 • HOUSTON, TEXAS 77251-1443

Copyright © 2002 – 2006, Texas Instruments Incorporated

CDCV304

140-MHz PCI-X CLOCK BUFFER

SCAS643C – SEPTEMBER 2000 REVISED AUGUST 2006

Terminal Functions

TERMINAL NAME	NO.	I/O	DESCRIPTION
1Y[0–3]	3, 5, 7, 8	O	Buffered output clocks
CLKIN	1	I	Input reference frequency
GND	4	Power	Ground
OE	2	I	Outputs enable control
V _{DD} 3.3V	6	Power	3.3-V supply

absolute maximum ratings over operating free-air temperature (unless otherwise noted)†

Supply voltage range, V_{DD} –0.5 V to 4.3 V
 Input voltage range, V_I (see Notes 1 and 2) –0.5 V to V_{DD} + 0.5 V
 Output voltage range, V_O (see Notes 1 and 2) –0.5 V to V_{DD} + 0.5 V
 Input clamp current, I_{IK} (V_I < 0 or V_I > V_{DD}) ±50 mA
 Output clamp current, I_{OK} (V_O < 0 or V_O > V_{DD}) ±50 mA
 Continuous total output current, I_O (V_O = 0 to V_{DD}) ±50 mA
 Package thermal impedance, θ_{JA} (see Note 3): PW package 230.5°C/W
 Storage temperature range, T_{stg} –65°C to 150°C

† Stresses beyond those listed under “absolute maximum ratings” may cause permanent damage to the device. These are stress ratings only, and functional operation of the device at these or any other conditions beyond those indicated under “recommended operating conditions” is not implied. Exposure to absolute-maximum-rated conditions for extended periods may affect device reliability.

- NOTES: 1. The input and output negative-voltage ratings may be exceeded if the input and output clamp-current ratings are observed.
 2. This value is limited to 4.6 V maximum.
 3. The package thermal impedance is calculated in accordance with JESD 51.

recommended operating conditions

	MIN	NOM	MAX	UNIT
Supply voltage, V _{DD}	3	3.3	3.6	V
High-level input voltage, V _{IH}	0.7×V _{DD}			V
Low-level input voltage, V _{IL}	0.3×V _{DD}			V
Input voltage, V _I	0		V _{DD}	V
High-level output current, I _{OH}				–24 mA
Low-level output current, I _{OL}				24 mA
Operating free-air temperature, T _A	–40		85	°C

timing requirements over recommended ranges of supply voltage and operating free-air temperature

	MIN	NOM	MAX	UNIT
f _{clk} Clock frequency	0		140	MHz



electrical characteristics over recommended operating free-air temperature range (unless otherwise noted)

PARAMETER		TEST CONDITIONS	MIN	TYP†	MAX	UNIT
V _{IK}	Input voltage	V _{DD} = 3 V, I _I = -18 mA			-1.2	V
V _{OH}	High-level output voltage	V _{DD} = min to max, I _{OH} = -1 mA	V _{DD} -0.2			V
		V _{DD} = 3 V, I _{OH} = -24 mA	2			
		V _{DD} = 3 V, I _{OH} = -12 mA	2.4			
V _{OL}	Low-level output voltage	V _{DD} = min to max, I _{OL} = 1 mA	0.2			V
		V _{DD} = 3 V, I _{OL} = 24 mA	0.8			
		V _{DD} = 3 V, I _{OL} = 12 mA	0.55			
I _{OH}	High-level output current	V _{DD} = 3 V, V _O = 1 V	-50			mA
		V _{DD} = 3.3 V, V _O = 1.65 V	-55			
I _{OL}	Low-level output current	V _{DD} = 3 V, V _O = 2 V	60			mA
		V _{DD} = 3.3 V, V _O = 1.65 V	70			
I _I	Input current	V _I = V _O or V _{DD}			±5	μA
I _{DD}	Dynamic current, See Figure 5	f = 67 MHz			37	mA
C _i	Input capacitance	V _{DD} = 3.3 V, V _I = 0 V or V _{DD}		3		pF
C _o	Output capacitance	V _{DD} = 3.3 V, V _I = 0 V or V _{DD}		3.2		pF

† All typical values are at respective nominal V_{DD} and 25°C.

switching characteristics over recommended ranges of supply voltage and operating free-air temperature, C_L = 10 pF, V_{DD} = 3.3 V ± 0.3 V (see Note 6 and Figures 1 and 2)

PARAMETER		TEST CONDITIONS	MIN	TYP†	MAX	UNIT
t _{PLH}	High-to-low propagation delay	See Figures 1 and 2	1.8	2.5	3	ns
t _{PHL}	Low-to-high propagation delay		1.8	2.4	3	ns
t _{sk(o)}	Output skew (see Note 4)			50	100	ps
t _{sk(p)}	Pulse skew	V _{IH} = V _{DD} , V _{IL} = 0 V			150	ps
t _{sk(pr)}	Process skew			0.2	0.3	ns
t _{sk(pp)}	Part-to-part skew			0.25	0.4	ns
T _{high}	CLK high time, See Figure 4	66 MHz	6			ns
		140 MHz	3			
T _{low}	CLK low time, See Figure 4	66 MHz	6			ns
		140 MHz	3			
t _r	Output rise slew rate‡	0.2V _{DD} to 0.6V _{DD}	1.5	2.7	4	V/ns
t _f	Output fall slew rate‡	0.6V _{DD} to 0.2V _{DD}	1.5	2.7	4	V/ns

† All typical values are at respective nominal V_{DD}.

‡ This symbol is according to PCI-X terminology.

NOTE 4: The t_{sk(o)} specification is only valid for equal loading of all outputs.

CDCV304 140-MHz PCI-X CLOCK BUFFER

SCAS643C – SEPTEMBER 2000 REVISED AUGUST 2006

PARAMETER MEASUREMENT INFORMATION

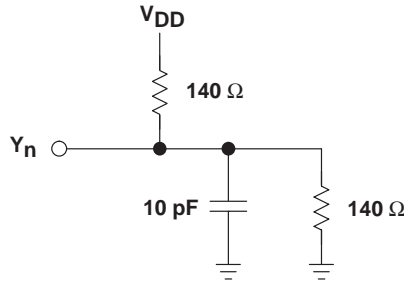

Figure 1. Test Load Circuit

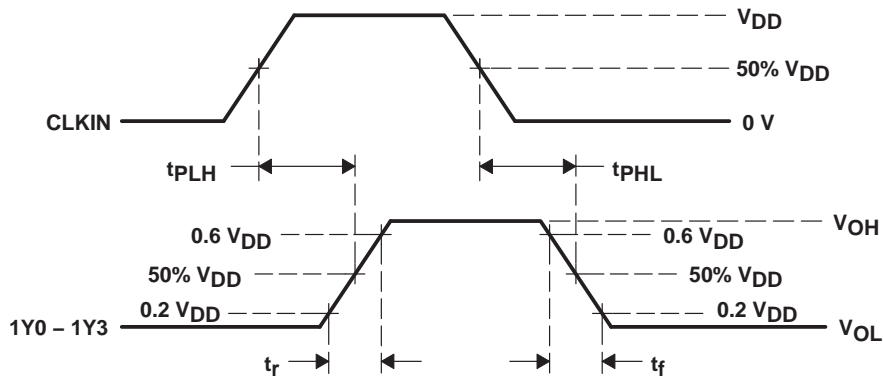

Figure 2. Voltage Thresholds for Propagation Delay (t_{pd}) Measurements

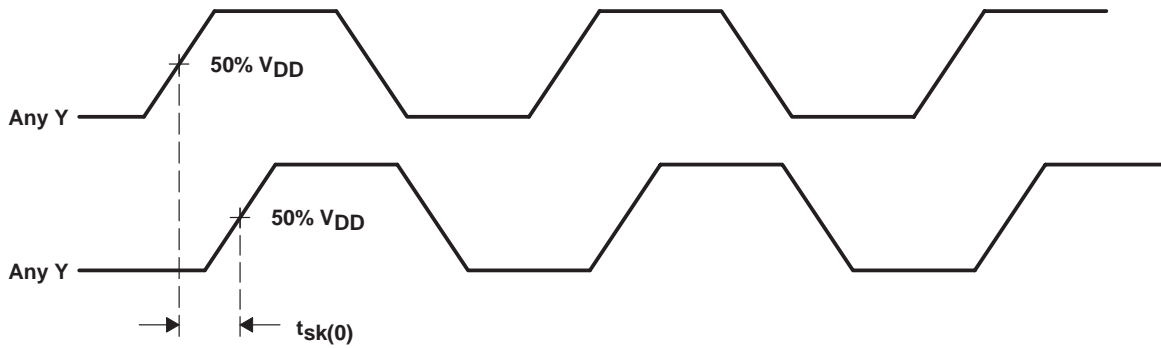
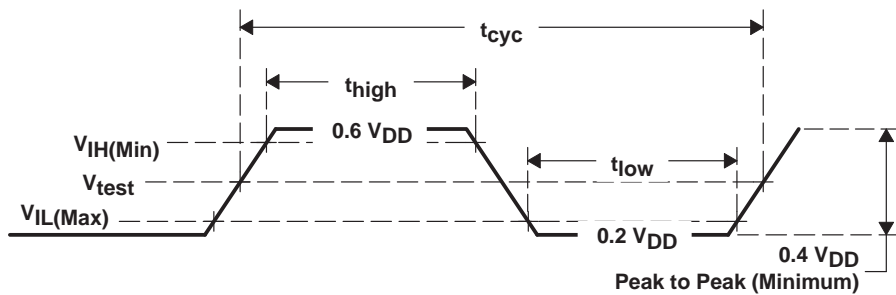

Figure 3. Output Skew

PARAMETER	VALUE	UNIT
$V_{IH}(\text{Min})$	$0.5 V_{DD}$	V
$V_{IL}(\text{Max})$	$0.35 V_{DD}$	V
V_{test}	$0.4 V_{DD}$	V



NOTE: All parameters in Figure 4 are according to PCI-X 1.0 specifications.

Figure 4. Clock Waveform



PARAMETER MEASUREMENT INFORMATION

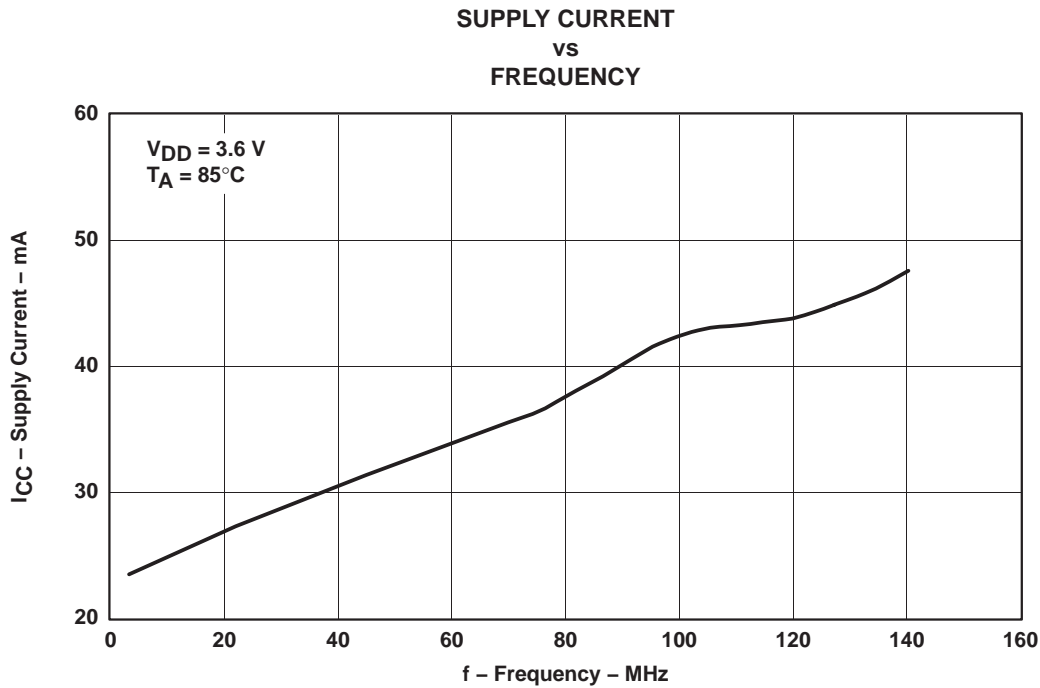

Figure 5

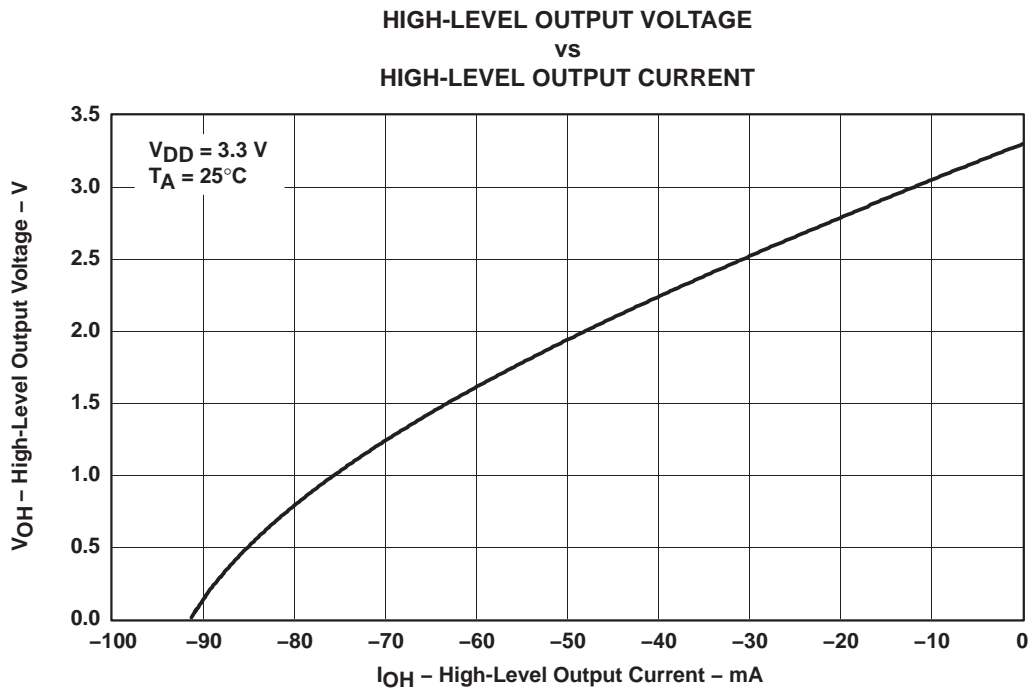

Figure 6

CDCV304

140-MHz PCI-X CLOCK BUFFER

SCAS643C – SEPTEMBER 2000 REVISED AUGUST 2006

PARAMETER MEASUREMENT INFORMATION

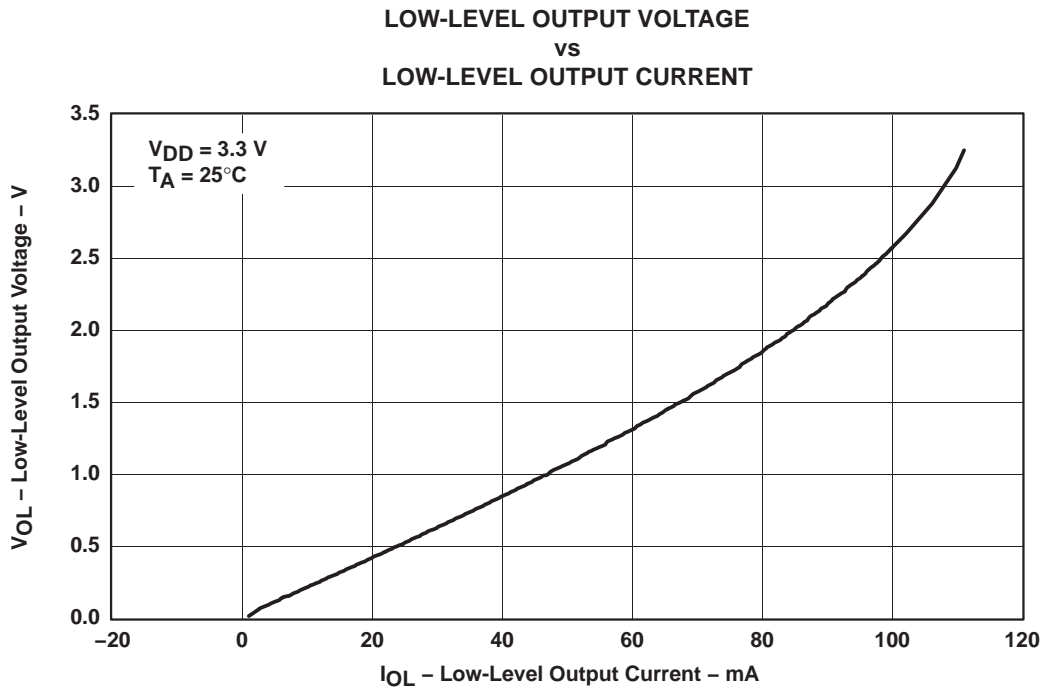

Figure 7

Revision History

DATE	REV	PAGE	SECTION	DESCRIPTION
8/23/06	A	5	Parameter Measurement Information	Changed Figure 5 deleting the first 2 MHz line from the drawing.

NOTE: Page numbers for previous revisions may differ from page numbers in the current version.

PACKAGING INFORMATION

Orderable Device	Status ⁽¹⁾	Package Type	Package Drawing	Pins	Package Qty	Eco Plan ⁽²⁾	Lead/Ball Finish	MSL Peak Temp ⁽³⁾
CDCV304PW	ACTIVE	TSSOP	PW	8	150	Green (RoHS & no Sb/Br)	CU NIPDAU	Level-1-260C-UNLIM
CDCV304PWG4	ACTIVE	TSSOP	PW	8	150	Green (RoHS & no Sb/Br)	CU NIPDAU	Level-1-260C-UNLIM
CDCV304PWR	ACTIVE	TSSOP	PW	8	2000	Green (RoHS & no Sb/Br)	CU NIPDAU	Level-1-260C-UNLIM
CDCV304PWRG4	ACTIVE	TSSOP	PW	8	2000	Green (RoHS & no Sb/Br)	CU NIPDAU	Level-1-260C-UNLIM

⁽¹⁾ The marketing status values are defined as follows:

ACTIVE: Product device recommended for new designs.

LIFEBUY: TI has announced that the device will be discontinued, and a lifetime-buy period is in effect.

NRND: Not recommended for new designs. Device is in production to support existing customers, but TI does not recommend using this part in a new design.

PREVIEW: Device has been announced but is not in production. Samples may or may not be available.

OBSOLETE: TI has discontinued the production of the device.

⁽²⁾ Eco Plan - The planned eco-friendly classification: Pb-Free (RoHS), Pb-Free (RoHS Exempt), or Green (RoHS & no Sb/Br) - please check <http://www.ti.com/productcontent> for the latest availability information and additional product content details.

TBD: The Pb-Free/Green conversion plan has not been defined.

Pb-Free (RoHS): TI's terms "Lead-Free" or "Pb-Free" mean semiconductor products that are compatible with the current RoHS requirements for all 6 substances, including the requirement that lead not exceed 0.1% by weight in homogeneous materials. Where designed to be soldered at high temperatures, TI Pb-Free products are suitable for use in specified lead-free processes.

Pb-Free (RoHS Exempt): This component has a RoHS exemption for either 1) lead-based flip-chip solder bumps used between the die and package, or 2) lead-based die adhesive used between the die and leadframe. The component is otherwise considered Pb-Free (RoHS compatible) as defined above.

Green (RoHS & no Sb/Br): TI defines "Green" to mean Pb-Free (RoHS compatible), and free of Bromine (Br) and Antimony (Sb) based flame retardants (Br or Sb do not exceed 0.1% by weight in homogeneous material)

⁽³⁾ MSL, Peak Temp. -- The Moisture Sensitivity Level rating according to the JEDEC industry standard classifications, and peak solder temperature.

Important Information and Disclaimer:The information provided on this page represents TI's knowledge and belief as of the date that it is provided. TI bases its knowledge and belief on information provided by third parties, and makes no representation or warranty as to the accuracy of such information. Efforts are underway to better integrate information from third parties. TI has taken and continues to take reasonable steps to provide representative and accurate information but may not have conducted destructive testing or chemical analysis on incoming materials and chemicals. TI and TI suppliers consider certain information to be proprietary, and thus CAS numbers and other limited information may not be available for release.

In no event shall TI's liability arising out of such information exceed the total purchase price of the TI part(s) at issue in this document sold by TI to Customer on an annual basis.

PW (R-PDSO-G**)

PLASTIC SMALL-OUTLINE PACKAGE

14 PINS SHOWN



4040064/F 01/97

- NOTES: A. All linear dimensions are in millimeters.
 B. This drawing is subject to change without notice.
 C. Body dimensions do not include mold flash or protrusion not to exceed 0,15.
 D. Falls within JEDEC MO-153

IMPORTANT NOTICE

Texas Instruments Incorporated and its subsidiaries (TI) reserve the right to make corrections, modifications, enhancements, improvements, and other changes to its products and services at any time and to discontinue any product or service without notice. Customers should obtain the latest relevant information before placing orders and should verify that such information is current and complete. All products are sold subject to TI's terms and conditions of sale supplied at the time of order acknowledgment.

TI warrants performance of its hardware products to the specifications applicable at the time of sale in accordance with TI's standard warranty. Testing and other quality control techniques are used to the extent TI deems necessary to support this warranty. Except where mandated by government requirements, testing of all parameters of each product is not necessarily performed.

TI assumes no liability for applications assistance or customer product design. Customers are responsible for their products and applications using TI components. To minimize the risks associated with customer products and applications, customers should provide adequate design and operating safeguards.

TI does not warrant or represent that any license, either express or implied, is granted under any TI patent right, copyright, mask work right, or other TI intellectual property right relating to any combination, machine, or process in which TI products or services are used. Information published by TI regarding third-party products or services does not constitute a license from TI to use such products or services or a warranty or endorsement thereof. Use of such information may require a license from a third party under the patents or other intellectual property of the third party, or a license from TI under the patents or other intellectual property of TI.

Reproduction of information in TI data books or data sheets is permissible only if reproduction is without alteration and is accompanied by all associated warranties, conditions, limitations, and notices. Reproduction of this information with alteration is an unfair and deceptive business practice. TI is not responsible or liable for such altered documentation.

Resale of TI products or services with statements different from or beyond the parameters stated by TI for that product or service voids all express and any implied warranties for the associated TI product or service and is an unfair and deceptive business practice. TI is not responsible or liable for any such statements.

Following are URLs where you can obtain information on other Texas Instruments products and application solutions:

Products		Applications	
Amplifiers	amplifier.ti.com	Audio	www.ti.com/audio
Data Converters	dataconverter.ti.com	Automotive	www.ti.com/automotive
DSP	dsp.ti.com	Broadband	www.ti.com/broadband
Interface	interface.ti.com	Digital Control	www.ti.com/digitalcontrol
Logic	logic.ti.com	Military	www.ti.com/military
Power Mgmt	power.ti.com	Optical Networking	www.ti.com/opticalnetwork
Microcontrollers	microcontroller.ti.com	Security	www.ti.com/security
Low Power Wireless	www.ti.com/lpw	Telephony	www.ti.com/telephony
		Video & Imaging	www.ti.com/video
		Wireless	www.ti.com/wireless

Mailing Address: Texas Instruments
Post Office Box 655303 Dallas, Texas 75265